



AHE SERIES 4

Direct Vent Wall-Mounted Boilers

User's Information Manual



INSTALLER:

Please take time to review this User's Information Manual with the boiler owner. Explain all maintenance and service procedures and the correct Lighting or Operating Instructions.

WARNING

If the information in this manual is not followed exactly, a fire or explosion may result, causing property damage, personal injury or loss of life.

Do not store or use **gasoline or other flammable vapors and liquids** in the vicinity of this or any other appliance.

WHAT TO DO IF YOU SMELL GAS

- **Do not try to light any appliance.**
- **Do not touch any electrical switch; do not use any phone** in your building.
- **Immediately call your gas supplier from a neighbor's phone.** Follow the gas supplier's instructions.
- **If you cannot reach your gas supplier, call the fire department.**

Installation and service must be performed by a qualified installer, service technician or the gas supplier.



Please read this page first

Hazard definitions

The following defined terms are used throughout this manual to bring attention to the presence of hazards of various risk levels or to important information concerning the life of the product.

- DANGER** Indicates presence of hazards that will cause severe personal injury, death or substantial property damage.
- WARNING** Indicates presence of hazards that can cause severe personal injury, death or substantial property damage.
- CAUTION** Indicates presence of hazards that will or can cause minor personal injury or property damage.
- NOTICE** Indicates special instructions on installation, operation or maintenance that are important but not related to personal injury or property damage.

Contents

Hazard definitions	2
Stop!! — Read before proceeding — Important safety information	3
Boiler maintenance	4
User maintenance procedures	5-8
Operating instructions — Robertshaw 7200	9
Operating instructions — Honeywell VR8205 and White-Rodgers 36E	10
Common problems and solutions	11
Warranty	12



Stop!! — Read before proceeding

WARNING

Failure to adhere to the following guidelines can result in severe personal injury, death or substantial property damage.

When servicing boiler

- To avoid electric shock, disconnect electrical supply before performing maintenance.
- To avoid severe burns, allow boiler to cool before performing maintenance.

Boiler operation

- Do not block flow of combustion or ventilation air to boiler.
- Should overheating occur or gas supply fail to shut off, do not turn off or disconnect electrical supply to circulator. Instead, shut off the gas supply at a location external to the appliance.
- Do not use this boiler if any part has been under water. Immediately call a qualified service technician to inspect the boiler and to replace any part of the control system and any gas control that has been under water.

Boiler water

- Do not use petroleum-based cleaning or sealing compounds in boiler system. Water seal deterioration will occur, causing leakage between sections. This can result in substantial property damage.
- Do not use "homemade cures" or "boiler patent medicines". Serious damage to boiler, personnel and/or property may result.
- Continual fresh makeup water will reduce boiler life. Mineral buildup in sections reduces heat transfer, overheats cast iron, and causes section failure. Addition of oxygen and other gases can cause internal corrosion. Leaks in boiler or piping must be repaired at once to prevent makeup water.
- Do not add cold water to hot boiler. Thermal shock can cause sections to crack.

Glycol — potential fire hazard

All glycol is flammable when exposed to high temperatures. If glycol is allowed to accumulate in or around the boiler or any other potential ignition source, a fire can develop. In order to prevent potential severe personal injury, death or substantial property damage from fire and/or structural damage:

- Never store glycol of any kind near the boiler or any potential ignition source.
- Monitor and inspect the system and boiler regularly for leakage. Repair any leaks immediately to prevent possible accumulation of glycol.
- Never use automotive antifreeze or ethylene glycol in the system. Using these glycols can lead to hazardous leakage of glycol in the boiler system.



Boiler maintenance

Boiler service and maintenance

The User’s Information Manual provides information to the boiler owner/user for routine operation and maintenance and emergency shutdown. Detailed information on boiler installation, operation, start-up, service and parts is included in the Boiler Manual. **The Boiler Manual is intended only for use by a qualified installer/service technician.**

Maintenance schedule

Maintain the boiler using the maintenance schedule below. Have the boiler started up and serviced at least annually by a qualified service technician to ensure boiler/system reliability.

Service technician (covered in Boiler Manual — for use only by a qualified service technician)		Owner maintenance (see following pages for instructions)			
ANNUAL START-UP	Inspect:		<ul style="list-style-type: none"> • Check boiler area • Check air openings • Check boiler pressure/temperature gauge 		
	<ul style="list-style-type: none"> • Reported problems • Boiler area • Air openings • Flue gas vent system (and air piping) • Main burner flames • Water piping • Boiler heating surfaces • Burners and base 		Monthly	<ul style="list-style-type: none"> • Check boiler piping • Check venting system • Check boiler relief valve • Check automatic air vents • Main burner flames 	
	Service:	<ul style="list-style-type: none"> • Cleaning boiler heating surfaces • Blower motor • Oiled-bearing circulators 		Periodically	<ul style="list-style-type: none"> • Test low water cutoff • Clean vent termination and air intake screens
	Start-up:	<ul style="list-style-type: none"> • Perform start-up per manual 		Every 6 months	<ul style="list-style-type: none"> • Operate relief valve
	Check/test:	<ul style="list-style-type: none"> • Gas piping • Cold fill and operating pressures • Air vents and air elimination • Blower motor assembly • Circulator with mixing valve • Limit controls and cutoffs • Expansion tank • Boiler relief valve 		End of season	<ul style="list-style-type: none"> • Shut down procedure
Review:	<ul style="list-style-type: none"> • Review with owner 				



User maintenance procedures

Boiler must be serviced and maintained

WARNING

The boiler should be inspected and started annually, at the beginning of the heating season, only by a qualified service technician. In addition, the maintenance and care of the boiler, as explained on the following pages, must be performed to assure maximum boiler efficiency and reliability. Failure to service and maintain the boiler and system could result in equipment failure, causing possible severe personal injury, death or substantial property damage.

NOTICE

The following information provides detailed instructions for completing the maintenance items listed in the maintenance schedule on page 4. In addition to this maintenance, the boiler must be serviced and started up at the beginning of each heating season by a qualified service technician.

Component information

For detailed illustrations showing boiler assembly parts and components, refer to the “Replacement parts” section in the AHE Series 4 Boiler Manual.

Rollout thermal fuse element

Cuts off gas flow should flame rollout occur. See Figure 1.

WARNING

Do not attempt to place boiler in operation if rollout thermal fuse element cuts off gas flow. Immediately call a service technician. Failure to do so can cause severe personal injury, death or substantial property damage.

Figure 1 Rollout thermal fuse element

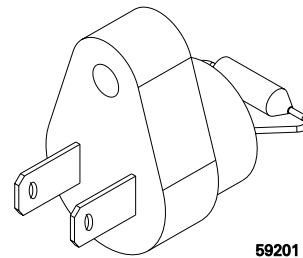

Daily

Check boiler area

WARNING

To prevent potential of severe personal injury, death or substantial property damage, do not store combustible materials, gasoline or any other flammable vapors or liquids near the boiler. Remove immediately if found.

Check air openings

1. Verify that combustion and ventilation air openings to the boiler room and/or building are open and unobstructed.
2. Verify that boiler air intake is clean and free of obstructions. Remove any debris on the air intake opening.

Daily

Check boiler pressure/temperature gauge

1. Make sure the pressure reading on the boiler pressure/temperature gauge does not exceed 24 psig. Higher pressure may indicate a problem with the expansion tank or gauge.
2. Contact a qualified service technician if problem persists.



User maintenance procedures continued

☐ Monthly

Check boiler piping

Visually inspect for leaks around piping, circulators, relief valve and other fittings. Immediately call a qualified service technician to repair any leaks.

WARNING

Have leaks fixed at once by a qualified service technician. Continual fresh makeup water will reduce boiler life. Minerals can build up in sections, reducing heat transfer, overheating cast iron and causing equipment failure. Leaking water may also cause severe property damage.

WARNING

Do not use petroleum-based cleaning or sealing compounds in boiler system. Severe damage to boiler and system components can occur, resulting in possible severe personal injury, death or substantial property damage.

Check venting system

WARNING

Failure to inspect the vent system as noted below and have them repaired by a qualified service technician can result in vent system failure, causing severe personal injury or death.

1. Visually inspect the gas vent system for any signs of blockage, leakage of joints or deterioration of the piping.

☐ Monthly

Check boiler relief valve

1. Inspect the boiler relief valve (see Figure 2) and the relief valve discharge pipe for signs of weeping or leakage.
2. If the relief valve often weeps:
 - The expansion tank may not be working properly.
 - Immediately contact your qualified service technician to inspect the boiler and system.

Check automatic air vents

1. See Figure 3.
2. Remove the cap from any automatic air vent in the system and check operation by depressing valve “B” slightly with the tip of a screwdriver.
3. If the air vent valve appears to be working freely and not leaking, replace cap “A”, twisting all the way on.
4. Loosen cap “A” one turn to allow vent to operate.
5. Have vent replaced if it does not operate correctly.

Figure 2
Relief valve

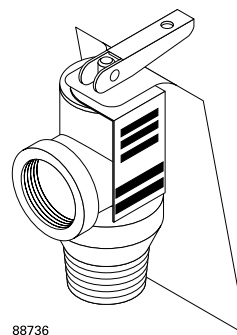
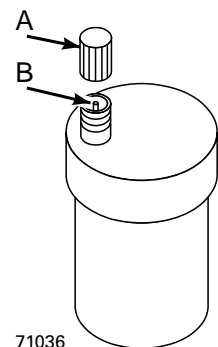

Figure 3
Automatic air vent





User maintenance procedures continued

□ Monthly

Main burner flames

1. See Figure 4. Remove burner input plenum cover plate “A”.
2. Visually inspect burner flames:
 - **Proper** main burner flame (see Figure 5):
 - a. Yellow-orange streaks may appear (caused by dust).
 - **Improper** main burner flame:
 - a. Overfired — Large flames.
 - b. Underfired — Small flames.
 - c. Lack of primary air — Yellow tipping on flames (sooting will occur).

□ Periodically

Test low water cutoff

Test the low water cutoff periodically during the heating season, following the low water cutoff manufacturer’s instructions.

Clean vent termination and air intake screens

1. Remove all lint and debris from both the boiler air intake screen and the flue discharge screen.
2. The boiler control module will sense blockage of the air intake or flue and lockout if the blockage is excessive. It will signal by flashing the appropriate indicator lights on the control board.
3. If removing the debris does not allow the boiler to operate correctly afterwards, contact your qualified service technician to inspect the boiler and vent/air systems.

Figure 4

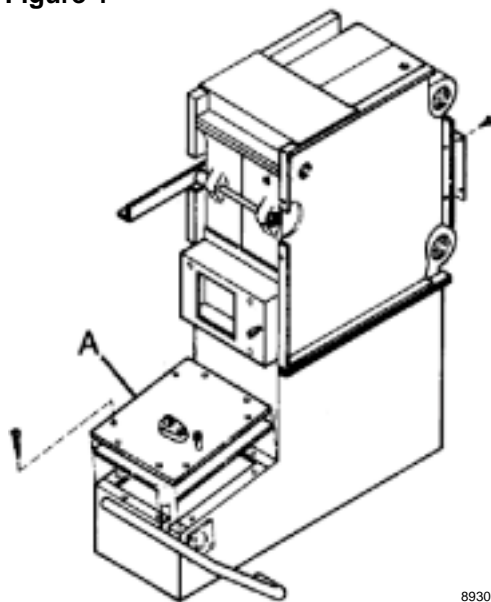

89301

Figure 5 Main burner flame, typical

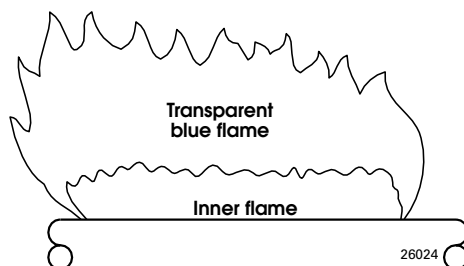

26024



User maintenance procedures continued

☐ Every 6 months

☐ End of season

Operate relief valve

WARNING

To avoid water damage or scalding due to valve operation, a metal discharge line must be connected to relief valve outlet and run to a safe place of disposal. This discharge line must be installed by a qualified heating installer or service technician in accordance with the instructions in the AHE Series 4 Boiler Manual. The discharge line must be terminated so as to eliminate possibility of severe burns should the valve discharge.

1. Before proceeding, verify that the relief valve outlet has been piped to a safe place of discharge, avoiding any possibility of scalding from hot water.
2. Read the boiler pressure/temperature gauge to make sure the system is pressurized.
3. Lift the relief valve top lever slightly, allowing water to relieve through the valve and discharge piping.
4. If water flows freely, release the lever and allow the valve to seat. Watch the end of the relief valve discharge pipe to ensure that the valve does not weep after the line has had time to drain. If the valve weeps, lift the seat again to attempt to clean the valve seat. If the valve continues to weep afterwards, contact your qualified service technician to inspect the valve and system.
5. If water does not flow from the valve when you lift the lever completely, the valve or discharge line may be blocked. Immediately shutdown the boiler, following the Operating Instructions on the inside of the jacket top panel or on pages 10 and 11 of this manual. Call your qualified service technician to inspect the boiler and system

WARNING

Propane boilers only — Your propane supplier mixes an odorant with the propane to make its presence detectable. In some instances, the odorant can fade and the gas may no longer have an odor.

- Propane gas can accumulate at floor level. Smell near the floor for the gas odorant or any unusual odor. If you suspect a leak, do not attempt to light the pilot.
- Use caution when attempting to light the propane pilot. This should be done by a qualified service technician, particularly if pilot outages are common.
- Periodically check the odorant level of your gas.
- Inspect boiler and system at least yearly to make sure all gas piping is leak-tight.
- Consult your propane supplier regarding installation of a gas leak detector. There are some products on the market intended for this purpose. Your supplier may be able to suggest an appropriate device.

Shut down procedure

1. Follow “TO TURN OFF GAS TO THE APPLIANCE” instructions found in the Operating Instructions located on the inside of the jacket top panel. You will also find these instructions on pages 9 and 10 of this manual. Use the Operating Instructions for the gas valve model installed on the boiler.
2. Do not drain system unless exposure to freezing temperatures will occur.
3. Do not drain the system if it is filled with an antifreeze solution.
4. Do not shut down boilers used for domestic water heating. They must operate year-round.



Operating instructions

Robertshaw 7200 gas valve

FOR YOUR SAFETY READ BEFORE OPERATING

WARNING

If you do not follow these instructions exactly, a fire or explosion may result causing property damage, personal injury or loss of life.

- A. This appliance is equipped with an ignition device which automatically lights the pilot. **Do not** try to light the pilot by hand.
- B. Before **OPERATING**, smell all around the appliance area for gas. Be sure to smell next to the floor because some gas is heavier than air and will settle on the floor. See below.
- C. Use only your hand to turn the gas control knob. Never use tools. If the knob will not turn by hand, don't try to repair it, call a qualified service technician. Force or attempted repair may result in a fire or explosion.
- D. Do not use this appliance if any part has been under water. Immediately call a qualified service technician to inspect the appliance and to replace any part of the control system and any gas control, which has been under water.

WHAT TO DO IF YOU SMELL GAS

- Do not try to light any appliance.
- Do not touch any electric switch; do not use any phone in your building.
- Immediately call your gas supplier from a neighbor's phone. Follow the gas supplier's instructions.
- If you cannot reach your gas supplier, call the fire department.

OPERATING INSTRUCTIONS

1. **Stop!** Read the safety information above on this label.
2. Set the thermostat to lowest setting.
3. Turn off all electrical power to the appliance.
4. Remove control access panel.
5. This appliance is equipped with an ignition device which automatically lights the burner. Do not try to light the burner by hand.
6. Depress and move **selector arm** counterclockwise ↶ to **OFF**. **Note:** Selector arm cannot be moved to **OFF** unless selector arm is depressed slightly. Do not force.
7. Wait five (5) minutes to clear out any gas. Then smell for gas, including near the floor. If you smell gas, **STOP!** Follow "**B**" in the safety information above. If you don't smell gas, go to the next step.
8. Turn **selector arm** clockwise ↷ to **ON**.
9. Turn on all electric power to the appliance.
10. Set thermostat to desired setting.
11. If the appliance will not operate, follow the instructions "**To Turn Off Gas To Appliance**" below and call your service technician or gas supplier.
12. Replace control access panel.

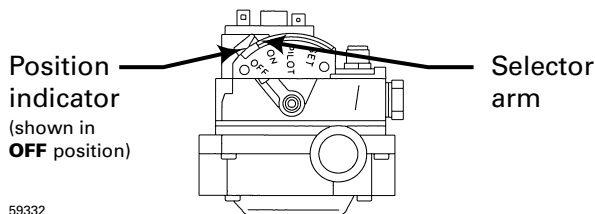

59332

TO TURN OFF GAS TO THE APPLIANCE

1. Set the thermostat to lowest setting.
2. Turn off all electric power to the appliance if service is to be performed.
3. Remove control access panel.
4. Depress and move **selector arm** counterclockwise ↶ to **OFF**. Do not force.
5. Replace control access panel.



Operating instructions — Robertshaw 7200 gas valve Honeywell VR8205 and White-Rodgers 36E gas valves

FOR YOUR SAFETY READ BEFORE OPERATING

WARNING

If you do not follow these instructions exactly, a fire or explosion may result causing property damage, personal injury or loss of life.

- A. This appliance is equipped with an ignition device which automatically lights the pilot. **Do not** try to light the pilot by hand.
- B. Before **OPERATING**, smell all around the appliance area for gas. Be sure to smell next to the floor because some gas is heavier than air and will settle on the floor. See below.
- C. Use only your hand to turn the gas control knob. Never use tools. If the knob will not turn by hand, don't try to repair it, call a qualified service technician. Force or attempted repair may result in a fire or explosion.
- D. Do not use this appliance if any part has been under water. Immediately call a qualified service technician to inspect the appliance and to replace any part of the control system and any gas control, which has been under water.

WHAT TO DO IF YOU SMELL GAS

- Do not try to light any appliance.
- Do not touch any electric switch; do not use any phone in your building.
- Immediately call your gas supplier from a neighbor's phone. Follow the gas supplier's instructions.
- If you cannot reach your gas supplier, call the fire department.

OPERATING INSTRUCTIONS

1. **Stop!** Read the safety information above on this label.
2. Set the thermostat to lowest setting.
3. Turn off all electrical power to the appliance.
4. Remove control access panel.
5. This appliance is equipped with an ignition device which automatically lights the burner. Do not try to light the burner by hand.
6. Turn **gas control knob** clockwise ↻ to **OFF**.
7. Wait five (5) minutes to clear out any gas. Then smell for gas, including near the floor. If you smell gas, **STOP!** Follow "**B**" in the safety information above. If you don't smell gas, go to the next step.
8. Turn **gas control knob** counterclockwise ↺ to **ON**.
9. Turn on all electric power to the appliance.
10. Set thermostat to desired setting.
11. If the appliance will not operate, follow the instructions "**To Turn Off Gas To Appliance**" below and call your service technician or gas supplier.
12. Replace control access panel.

88731

**White-Rodgers
36E Gas valve**

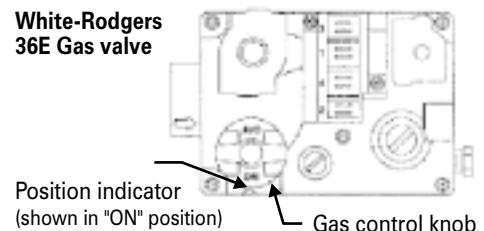

**Honeywell
VR8205
Gas valve**

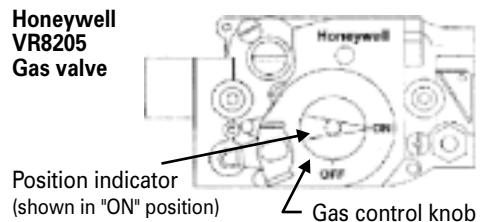

TO TURN OFF GAS TO THE APPLIANCE

1. Set the thermostat to lowest setting.
2. Turn off all electric power to the appliance if service is to be performed.
3. Remove control access panel.
4. Turn **gas control knob** clockwise ↻ to **OFF**. Do not force.
5. Replace control access panel.



Common problems and solutions

Symptom	Common Causes	Possible Corrections
Rapid cycling — boiler turns on and off frequently	Thermostat installed where drafts or heat affect reading	Locate thermostat on inner wall away from heat sources or cool drafts.
	Heat anticipator in thermostat adjusted incorrectly	Adjust thermostat per manufacturer's instructions.
	Incorrect limit setting	Set limit according to system needs. Maximum setting is 220°F. Increase limit setting to decrease cycling.
	Insufficient water flow through boiler	Check all valves to and from boiler. Return to proper setting. Confirm circulator size.
Frequent release of water through relief valve	Expansion tank sized too small	Call qualified service technician to check expansion tank operation and size.
	Flooded expansion tank	Call qualified service technician to check expansion tank operation.
	Inoperative limit control	Call qualified service technician to replace limit control.
Need to frequently add makeup water	Leaks in boiler or piping	Have qualified service technician repair leaks at once to avoid constant use of makeup water. Makeup water can cause mineral deposits which, in turn, can cause boiler section failure. Do not use petroleum-based stop-leak compounds.
Black water condition	Oxygen corrosion due to leaks in boiler and piping	Have qualified service technician repair at once. Keep pH of water between 7.0 to 8.5.
Popping or percolating noise heard in boiler	Mineral deposits in sections due to constant use of makeup water	Call qualified service technician to de-lime boiler, if necessary. In some cases, deposits will be too heavy to remove with de-liming procedures.
		Have qualified service technician repair leaks to eliminate need for constant makeup water.
	Incorrect pH of boiler water	Call qualified service technician to check pH level and correct. pH should be maintained between 7.0 to 8.5.
	Insufficient water flow through boiler	Check all valves to and from boiler. Return to proper setting. Confirm circulator size.
Metal flakes found in vent outlet or vent — flueway corrosion	Contaminated combustion air supply — See page 4 in this manual.	Remove any contaminating products. See page 3 in this manual.
		Provide outside air for combustion. Kit available through Weil-McLain distributor. Have qualified service technician pipe-up kit.
	Condensation of combustion gases in boiler sections	Have qualified service technician inspect system piping and controls to verify proper regulation of return water temperature.
Some radiators or baseboard units do not heat or are noisy	Air in system	Bleed air from system through air vents in radiators or baseboard units.
	Low system pressure	Fill to correct pressure.
		Check for leaks in boiler or piping. Have qualified service technician repair at once.
High limit set too low	Adjust high limit to higher setting.	

Weil-McLain Limited Warranty for Residential & Commercial Cast Iron Boilers

- ◆ **RESIDENTIAL WATER WARRANTY—Limited Lifetime**
- ◆ **RESIDENTIAL STEAM WARRANTY—Limited 10 Year**
- ◆ **COMMERCIAL WARRANTY—Limited 10-Year**

NOTE: The residential steam and water warranties do not cover residential boilers installed in buildings other than one or two family dwelling units, unless they are buildings with individual boilers for each dwelling unit.

First Year-(All Residential & Commercial Cast Iron Boilers)

Limited Warranty for Cast Iron Boilers:

Weil-McLain warrants that its cast iron boilers are free from defects in material and workmanship for one year from the date of installation. If any parts are found to be defective in manufacture, Weil-McLain will provide replacement of such defective parts.

Second Through Tenth Year-(Residential Water/Steam) Second Through Tenth Year-(Commercial Water/Steam)

Limited Warranty for cast iron sections:

Weil-McLain warrants that the cast iron sections of its water and steam boilers are free from defects in material and workmanship from the date of installation for the second through the tenth year. If, during such time period, any section is found to be defective, Weil-McLain will provide replacement for the original cast iron section(s).

Eleventh Year and Beyond - (Residential Water Only)

Limited Warranty for Cast Iron Sections:

Weil-McLain warrants that the cast iron sections of its residential water boilers are free from defects in material and workmanship for the eleventh year and beyond from the date of installation. If, during such time period, any section(s) is found to be defective, Weil-McLain will provide replacement for the original cast iron section(s) upon the payment of a proportionate charge based on the time the boiler has been in service. The proportionate charge will be equal to the appropriate percentage of the list price of such section(s) at the time the warranty claim is made, and will be determined as follows:

11th year - 5%; 12th year - 10%; 13th year - 15%;
14th year - 20%; 15th year - 25%; 16th year - 30%;
17th year - 35%; 18th year - 40%; 19th year - 45%;
20th year - 50%; 21st year - 55%; 22nd year - 60%;
23rd year - 65%; 24th year - 70%; 25th year and beyond - 75%.

All Residential & Commercial Cast Iron Boilers

These warranties are subject to the condition that the boiler must have been installed by a heating contractor whose principal occupation is the sale and installation of plumbing, heating and/or air conditioning equipment.

These warranties do not cover:

1. Components that are part of the heating systems, but were not furnished by Weil-McLain as a part of the boiler.
2. The workmanship of any installer of Weil-McLain's boilers. In addition, this warranty does not assume any liability of any nature for unsatisfactory performance caused by improper installation.
3. Any costs for labor for removal and reinstallation of the alleged defective part, transportation to Weil-McLain, if necessary, and any other materials necessary to perform the exchange.
4. Improper burner adjustments, control settings, care or maintenance. Information is included in the installation Instructions, Owner's Information Manual and/or Start-up, Service and Maintenance Instructions, and other printed technical material furnished by Weil-McLain with the boiler.
5. Boilers operated with combustion air contaminated externally by chemical vapors or with improper fuel additives, or with water conditions which may have caused unusual deposits in the cast iron sections.

These warranties extend only to the first retail purchaser of the boiler and only to a boiler that has not been moved from its original installation site.

THE WARRANTIES DESCRIBED ABOVE ARE IN LIEU OF ALL OTHER WARRANTIES, EXPRESS OR IMPLIED, INCLUDING BUT NOT LIMITED TO ANY IMPLIED WARRANTIES OF FITNESS FOR A PARTICULAR PURPOSE AND MERCHANTABILITY. WEIL-McLAIN EXPRESSLY DISCLAIMS AND EXCLUDES ANY LIABILITY FOR CONSEQUENTIAL, INCIDENTAL, INDIRECT OR PUNITIVE DAMAGES FOR BREACH OF ANY EXPRESS OR IMPLIED WARRANTY.

For prompt product warranty claims, notify the installer who, in turn, will notify the Weil-McLain distributor from whom he purchased the boiler. If this action does not result in warranty resolution, contact Weil-McLain Consumer Relations Department, 500 Blaine Street, Michigan City, Indiana 46360-2388, with details in support of the warranty claim. Alleged defective part or parts must be returned through trade channels in accordance with the Weil-McLain procedure currently in force for handling returned goods for the purpose of inspection to determine cause of failure. Weil-McLain will furnish new part(s) to an authorized Weil-McLain distributor who, in turn will furnish the new part(s) to the heating contractor who installed the boiler. If you have any questions about the coverage of this warranty, contact Weil-McLain at the address above.



WEIL-McLAIN
A United Dominion Company

Weil-McLain
500 Blaine Street
Michigan City, IN 46360-2388
<http://www.weil-mclain.com>