

# WEIL-McLAIN



**HE and VHE (Series 3) Hot Surface Ignition (HSI) System**

**Control  
Supplement**

**USING CONTROL SYSTEMS BY:  
WHITE-RODGERS  
FENWAL  
WITH NORTON 201N IGNITOR**

**FOR NATURAL OR PROPANE  
GAS-FIRED BOILERS**



# Table of Contents

Section I: Components ..... 4

## Section II: Sequence of Operatjon

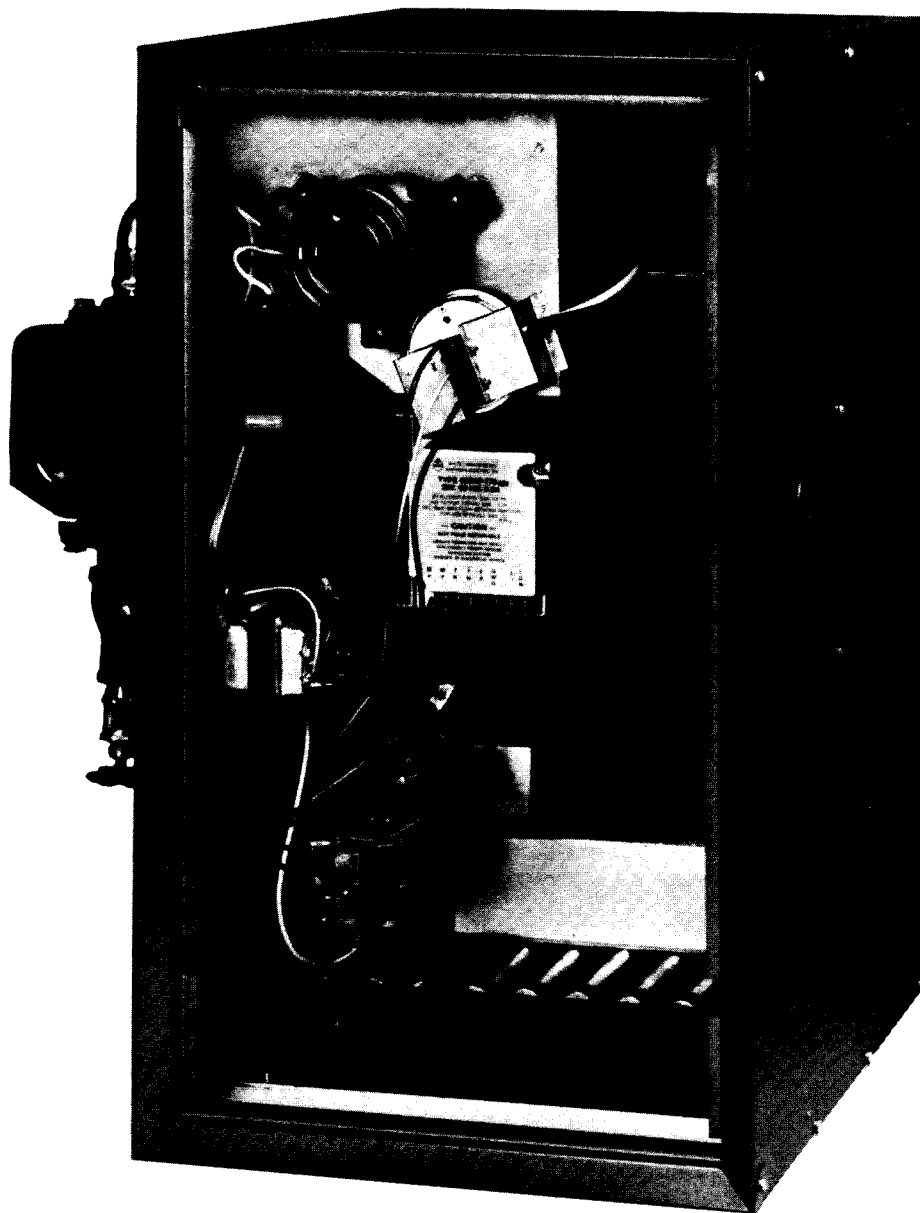
White-Rodgers:	
Sequence of Operation .....	5
Wiring Diagram .....	5
Fenwal:	
Sequence of Operation .....	6
Wiring Diagram .....	6

Section III: Troubleshooting Procedure ..... 7 – 15

Section IV: Parts List ..... back cover

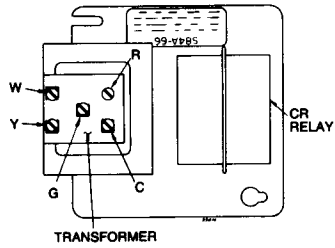
**IMPORTANT:** When calling or writing about the boiler, PLEASE GIVE THE MODEL AND SERIES located on the boiler rating label, AND C.P. NUMBER affixed next to rating label.

# HOT SURFACE IGNITION SYSTEM (WHITE-RODGERS SYSTEM SHOWN)

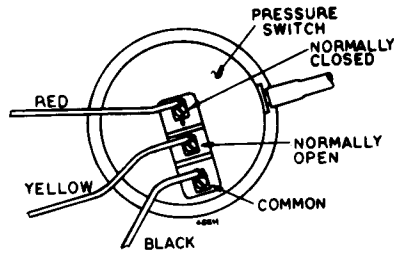


INDIVIDUAL COMPONENTS SHOWN ON PAGE 4

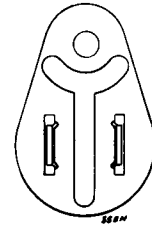
# Section I: Components



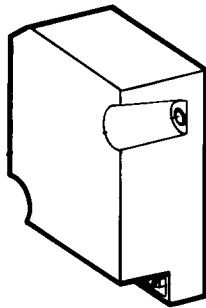
**120/24V 40 VA TRANSFORMER  
AND DPST CIRCULATOR RELAY  
FIGURE 1**



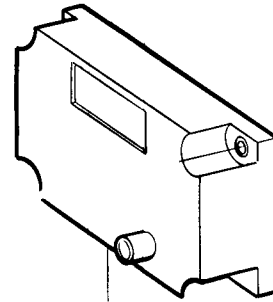
**PRESSURE SWITCH  
FIGURE 2**



**ROLLOUT THERMAL FUSE ELEMENT  
FIGURE 3**



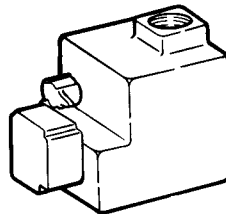
**WHITE-RODGERS IGNITION CONTROL  
(Powers gas valve and ignitor)  
FIGURE 4**



**FENWAL IGNITION CONTROL  
(Powers gas valve and ignitor)  
FIGURE 5**



**FLAME SENSOR  
FIGURE 6**



**GAS VALVE  
(Incorporates redundant solenoid  
valve, step-opening pressure  
regulator, and main valve operator)  
FIGURE 7**



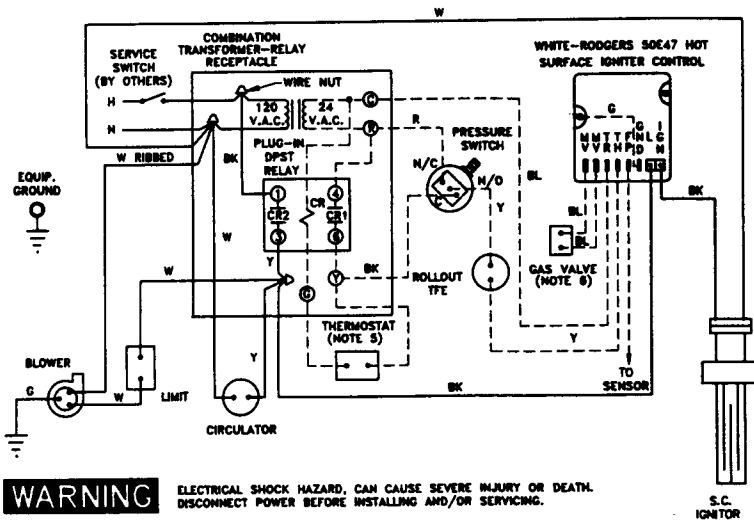
**IGNITOR  
(Heats to light main burners)  
FIGURE 8**

## Section II: Sequence of Operation

### WHITE-RODGERS HOT SURFACE IGNITION SYSTEM

1. Thermostat closes, activating relay CR (through pressure switch).
  - a) CR2 activates: circulator  
blower through limit switch
  - b) CR1 provides by-pass around pressure switch to prove its operation.
2. Pressure switch proves safe air flow, and switches to N.O. position, allowing 24 VAC through rollout thermal fuse element to ignition control.
3. 45-second ignitor heat-up.
4. 7-second trial for ignition:
  - a) Valve opens—low fire position
  - b) Flame rectification proves.
  - c) Power to ignitor off.
  - d) Main valve switches to high fire position.
5. After thermostat is satisfied, CR is deactivated:
  - a) CR2 opens turning off blower and pump.
  - b) CR1 opens turning off gas flow.
6. As air flow from blower reduces pressure, switch changes to normally closed position.
7. Boiler is now in "off" cycle.

#### SCHEMATIC WIRING DIAGRAM

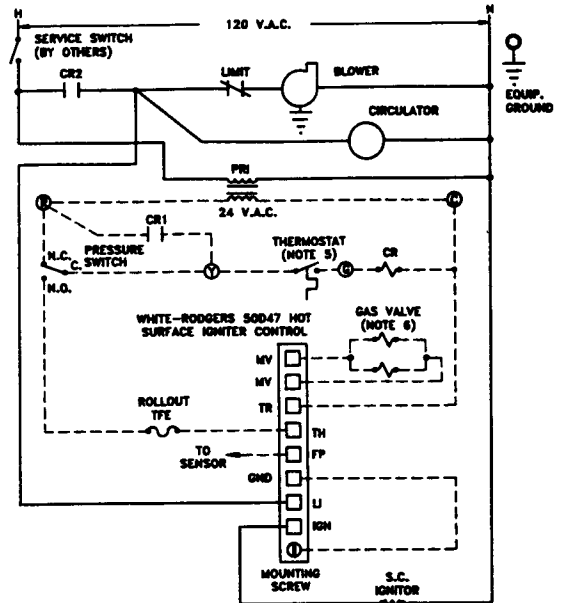


**WARNING** ELECTRICAL SHOCK HAZARD, CAN CAUSE SEVERE INJURY OR DEATH. DISCONNECT POWER BEFORE INSTALLING AND/OR SERVICING.

**NOTES:**

1. ALL WIRING MUST BE INSTALLED IN ACCORDANCE WITH:
  - A. U.S.A. - NATIONAL ELECTRICAL CODE AND ANY OTHER NATIONAL, STATE, OR LOCAL CODE REQUIREMENTS HAVING JURISDICTION.
  - B. CANADA - C.S.A. C22.1 CANADIAN ELECTRICAL CODE PART 1 AND ANY OTHER NATIONAL, PROVINCIAL, OR LOCAL CODE REQUIREMENTS HAVING JURISDICTION.
2. ALL SAFETY CIRCUIT WIRING MUST BE:
  - A. U.S.A. - N.E.C. CLASS 1.
  - B. CANADA - C.S.A. C22.1 C.E.C. PART 1.
3. IF ORIGINAL ROLLOUT SWITCH WIRE AS SUPPLIED WITH THE APPLIANCE MUST BE REPLACED, TYPE 200°C WIRE OR ITS EQUIVALENT MUST BE USED. IF OTHER ORIGINAL WIRE AS SUPPLIED WITH THE APPLIANCE MUST BE REPLACED, TYPE 80°C OR ITS EQUIVALENT MUST BE USED.
4. REFER TO CONTROL COMPONENT INSTRUCTIONS PACKED WITH BOILER FOR APPLICATION INFORMATION.
5. FOR SINGLE ZONE SYSTEMS, THERMOSTAT ANTICIPATOR SETTING IS 0.40 AMPS. FOR MULTIPLE ZONE SYSTEMS USING ZONE VALVES OR CIRCULATORS, REFER TO COMPONENT MANUFACTURER'S INSTRUCTIONS FOR APPLICATION, WIRING AND THERMOSTAT ANTICIPATOR SETTING.
6. GAS VALVE TERMINALS:  
WHITE-RODGERS - 1 AND 2  
HONEYWELL - TR AND TH

#### LADDER WIRING DIAGRAM



HIGH VOLTAGE —————  
LOW VOLTAGE - - - - -

NOTICE - ALL CONTACTS SHOWN WITHOUT POWER APPLIED - OFF SHELF CONDITION.

HE SERIES 3 SCHEMATIC AND LADDER WIRING DIAGRAMS, WHITE-RODGERS HOT SURFACE IGNITION SYSTEM, APPLICABLE FOR NATURAL OR PROPANE GAS-FIRED, FORCED HOT WATER BOILERS.

**WEIL-McLAIN**  
A Division of The Marley Company  
Michigan City, Indiana 46360

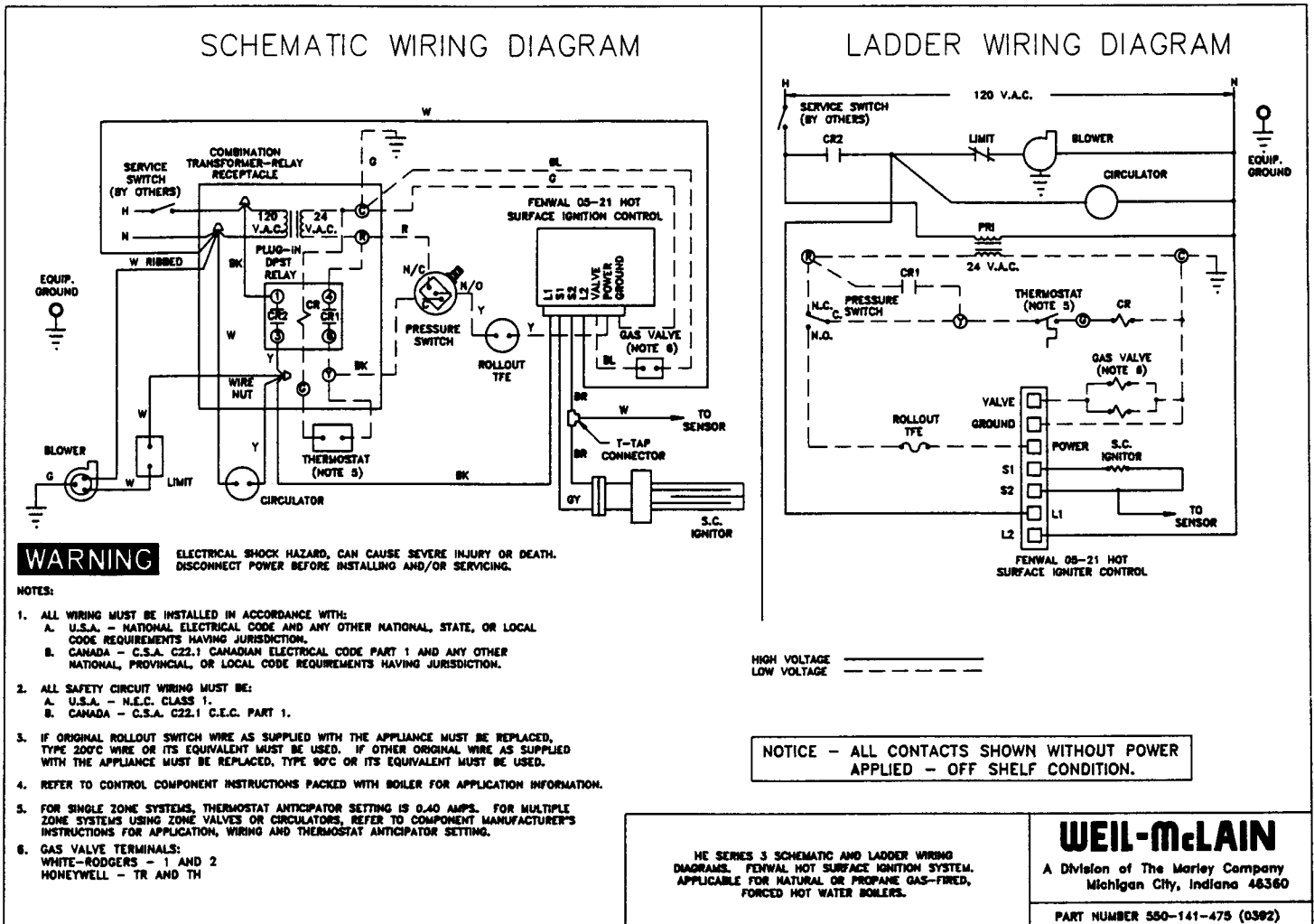
PART NUMBER 550-141-476/1290WM



## FENWAL HOT SURFACE IGNITION SYSTEM

1. Thermostat closes, activating relay CR (through pressure switch). Contacts CR1 and CR2 close:
  - a) CR2 activates: circulator  
blower through limit switch
  - b) CR1 provides by-pass around pressure switch to prove its operation.
2. Pressure switch proves safe air flow, and switches to N.O. position, allowing 24 VAC through rollout thermal fuse element to ignition control.
3. 45-second ignitor heat-up.
4. 7-second trial for ignition:
  - a) Valve opens—low fire position

- b) Flame rectification proves.
  - c) Power to ignitor off.
  - d) Main valve switches to high fire position.
5. After the thermostat is satisfied, CR is deactivated:
    - a) CR2 opens turning off blower and pump.
    - b) CR1 opens turning off gas flow.
  6. As air flow from blower reduces pressure; switch changes to normally closed position.
  7. Boiler is now in "off" cycle.



## Section III: Troubleshooting Procedure

### DANGER

NEVER jumper (by-pass) Rollout Thermal Fuse Element or any other safety device (except for momentary testing as outlined in Trouble Shooting Tables). A fire causing severe personal injury, death or substantial property damage will result.

### CAUTION

Access panel must be in position during boiler operation to prevent momentary flame rollout on ignition of main flame, which can melt rollout thermal fuse element and cause minor property damage. Never jumper rollout thermal fuse element.

#### A. Before trouble shooting:

1. Have a voltmeter capable of checking 120 VAC, 24 VAC and a continuity tester.
2. Have an inclined manometer with a range of 0–2.0" W.C.
3. Check for 120 VAC power supply available to the boiler (minimum 102 VAC, maximum 132 VAC).
4. Check for 24 VAC at the secondary side of the control transformer.
5. Check for good ground between boiler and ground bus bar at distribution panel.
6. Check gas pressures:
  - a) with boiler off
    - 13" W.C. maximum natural or propane gas pressure upstream of gas valve

#### b) with boiler on

- 5" W.C. minimum natural gas pressure or 11" W.C. propane upstream of gas valve
- 3½" W.C. minimum natural gas pressure or 10" W.C. propane downstream tapping on gas valve.

#### B. Visually check for following conditions:

1. White Rodgers Ignition Control—LED flashing or on steady—see Table I.
2. Ignitor does not glow—see Tables II, III, & V.
3. No main burner ignition—see Table VI.
4. Main burners come on and drop out—see Table VII.

## SPECIAL SERVICE TIPS

### IGNITOR

#### DANGER

Wait several minutes until ignitor cools down before attempting replacement. Failure to do so will cause severe personal injury.

1. Unplug ignitor and remove entire bracket assembly for service.
2. Ignitor is fragile. Handle with care.
3. Attach ignitor, ignitor shield, and flame sensor to ignitor bracket before installing.
4. If problem appears to be Norton 201N ignitor, **take cold ohm test when ignitor is at room temperature.** Ignitor must be at room temperature for test to be valid. Resistance must be less than 200 ohms.

#### NOTICE

If resistance measures above 200 ohms, ignitor will not function properly and must be replaced.

5. Fenwal System only – if flame sensor is unplugged, ignitor may temporarily hold in gas valve. Flame sensor must be plugged in for proper flame sensing.

### GAS VALVE

1. Install gas valve so that arrow points in direction of gas flow.

### IGNITION CONTROL

1. Make sure ground wire is attached per wiring diagram. Good grounding is extremely important for proper operation.
2. Polarity of 120VAC—verify connection between service switch and boiler junction box: **HOT TO HOT  
NEUTRAL TO NEUTRAL**



## CHECKING THE PRESSURE DIFFERENTIAL SWITCH

**NOTE:** Make sure boiler water temperature is 100°F. or cooler before beginning procedure.

1. Remove sensing tube at front of pressure switch (closest to you as you face the boiler).
2. Install a "T" into sensing tube. Run another piece of tubing from the "T" to the pressure switch.
3. Attach third leg of the "T" to suction side of an inclined manometer.
4. Remove sensing tube at the rear of pressure switch.
5. Install a "T" into sensing tube. Run another piece of tubing from the "T" to the pressure switch.
6. Attach third leg of the "T" to pressure side of the manometer.
7. Close manual main gas valve and set thermostat to call for heat. Blower will run but main burners will not ignite.
8. Check for 24 VAC between normally open terminal on pres-

sure switch and terminal C on transformer (Figures 1 and 2, page 4.). Then check for 24 VAC between pressure switch common terminal and terminal C on transformer.

9. If manometer reading is higher than 1.5 inches water column pressure, and voltmeter readings in step 8 are not 24 VAC each, replace pressure switch.
10. If reading is lower than 1.5" W.C. check for possible causes:
  - a) Blockage in sensing tube.
  - b) Obstruction in blower housing outlet.
  - c) Loose blower wheel on motor shaft.
  - d) Blower motor not at proper RPM.
  - e) Blower back plate not sealed properly.
  - f) Blockage in flue pipe or termination.
  - g) Blockage in block assembly.
  - h) Blockage in flue collector hood.
  - i) Dirt accumulation on flapper in transition box.
11. When pressure reading is proper and pressure switch is operating properly, remove "T"s and re-install sensing tubes to the pressure switch. Reset system by turning on and off main electrical switch.

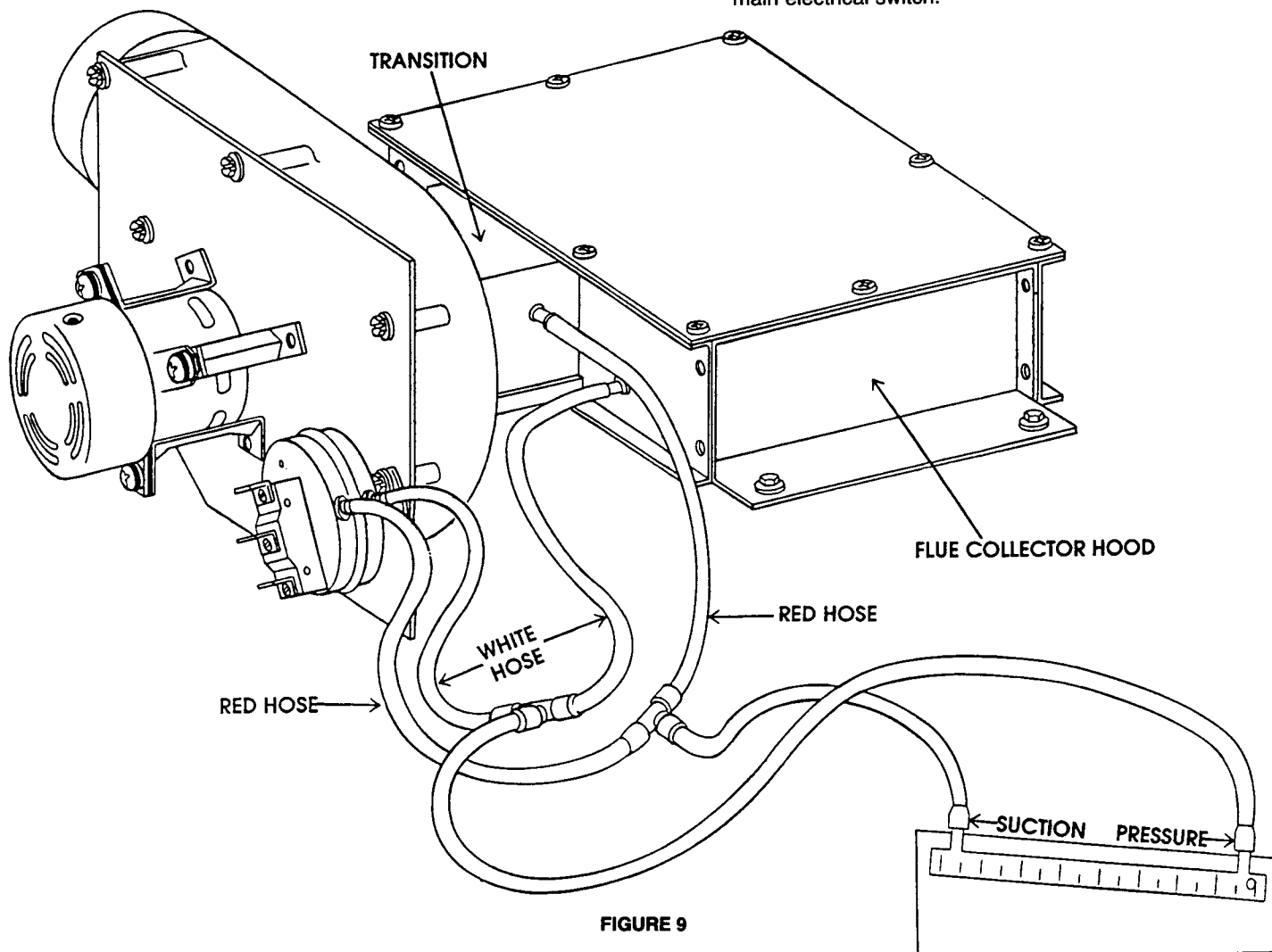
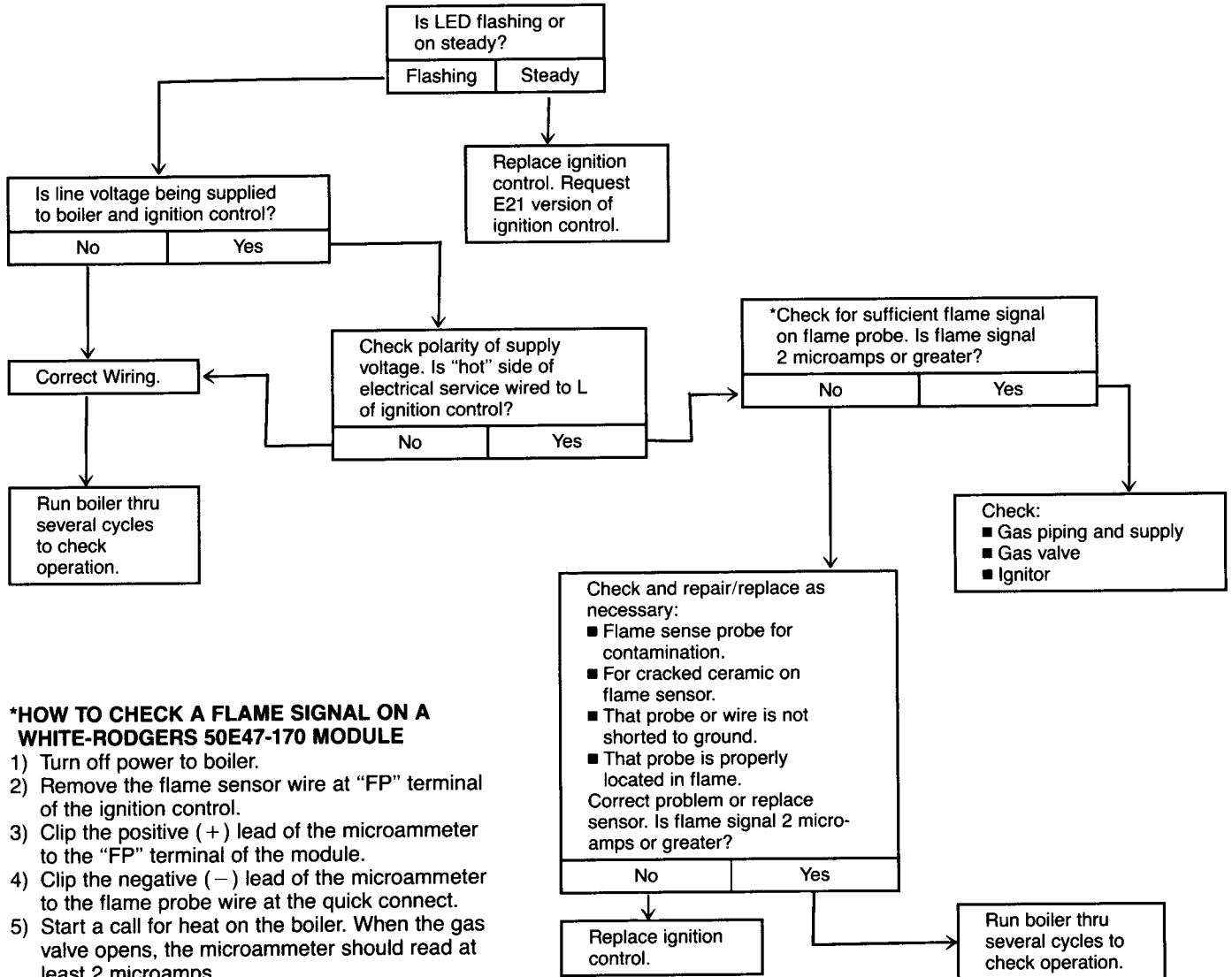


FIGURE 9

## TROUBLE SHOOTING GUIDES

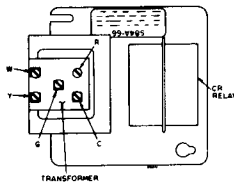
**TABLE I—WHITE-RODGERS IGNITION CONTROL ONLY—  
LOCKOUT LED FLASHING OR ON STEADY—NAT. GAS & PROPANE**



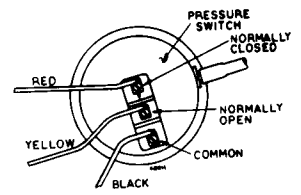
**\*HOW TO CHECK A FLAME SIGNAL ON A WHITE-RODGERS 50E47-170 MODULE**

- 1) Turn off power to boiler.
- 2) Remove the flame sensor wire at "FP" terminal of the ignition control.
- 3) Clip the positive (+) lead of the microammeter to the "FP" terminal of the module.
- 4) Clip the negative (-) lead of the microammeter to the flame probe wire at the quick connect.
- 5) Start a call for heat on the boiler. When the gas valve opens, the microammeter should read at least 2 microamps.

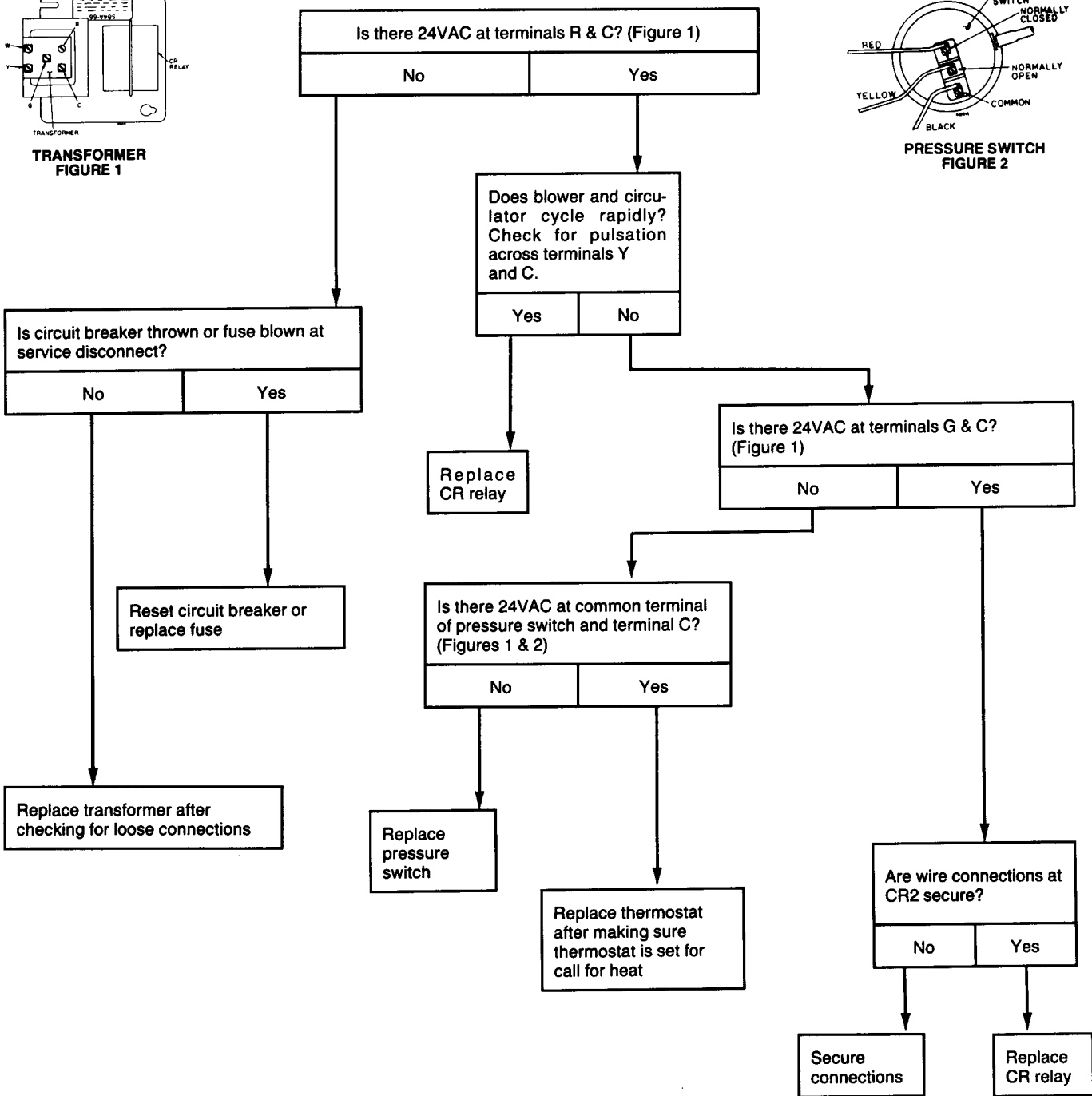
**TABLE II—BLOWER AND CIRCULATOR WILL NOT OPERATE—NAT. GAS & PROPANE**



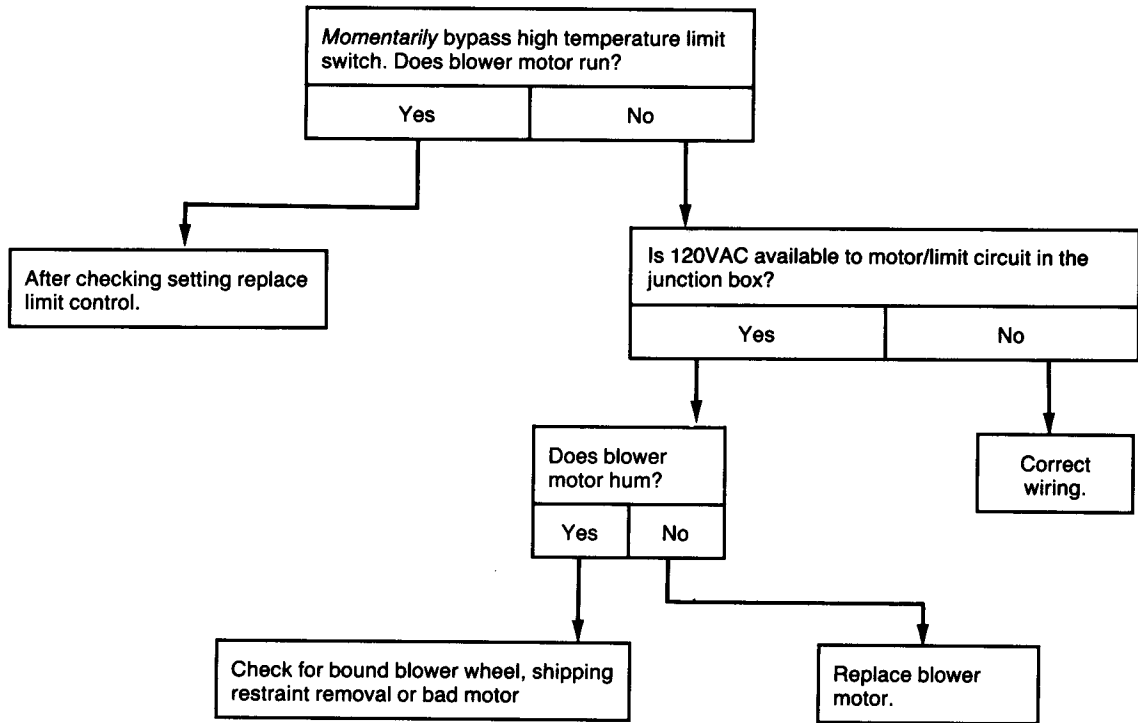
**TRANSFORMER  
FIGURE 1**



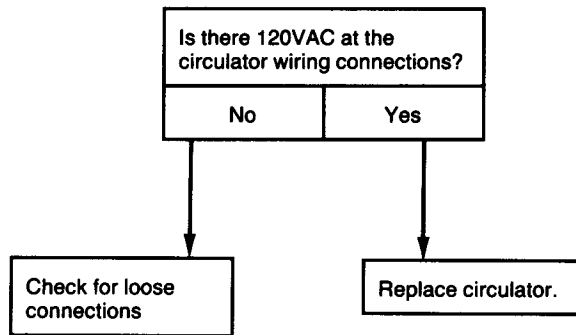
**PRESSURE SWITCH  
FIGURE 2**



**TABLE III—BLOWER WILL NOT OPERATE, BUT CIRCULATOR DOES OPERATE—NAT. GAS & PROPANE**



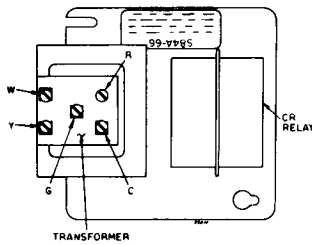
**TABLE IV—CIRCULATOR WILL NOT OPERATE, BUT BLOWER DOES OPERATE—NAT. GAS & PROPANE**



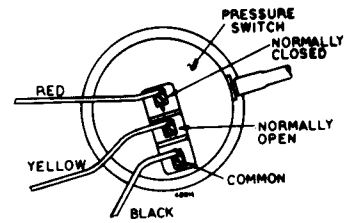
## TABLE V-IGNITOR WILL NOT GLOW-BLOWER & CIRCULATOR BOTH OPERATE-NAT. GAS & PROPANE

Before proceeding:

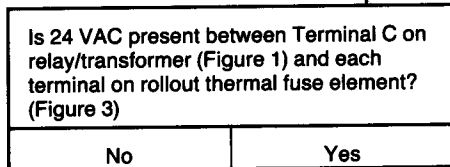
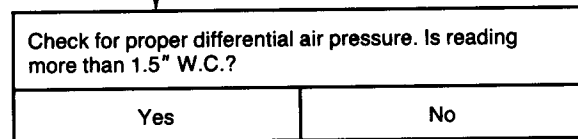
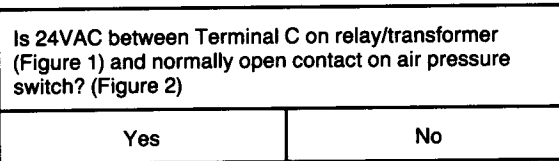
1. Check for lockout. Open thermostat, then close for call for heat.
2. Take cold ohm test of ignitor-see page 8.



120/24V 40 VA  
TRANSFORMER AND DPST  
CIRCULATOR RELAY  
FIGURE 1



PRESSURE SWITCH  
FIGURE 2



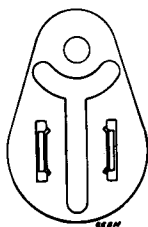
Replace pressure switch.

Refer to Step 10, Page 9 and correct problem.

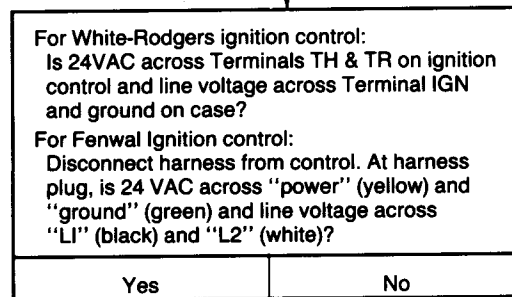
Check wiring then replace Rollout Thermal Fuse Element.

**WARNING**

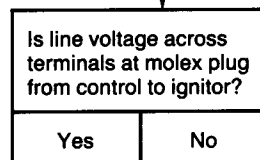
NEVER JUMPER OUT (BY-PASS) ROLLOUT THERMAL FUSE ELEMENT



ROLLOUT THERMAL FUSE ELEMENT  
FIGURE 3



Check wiring.



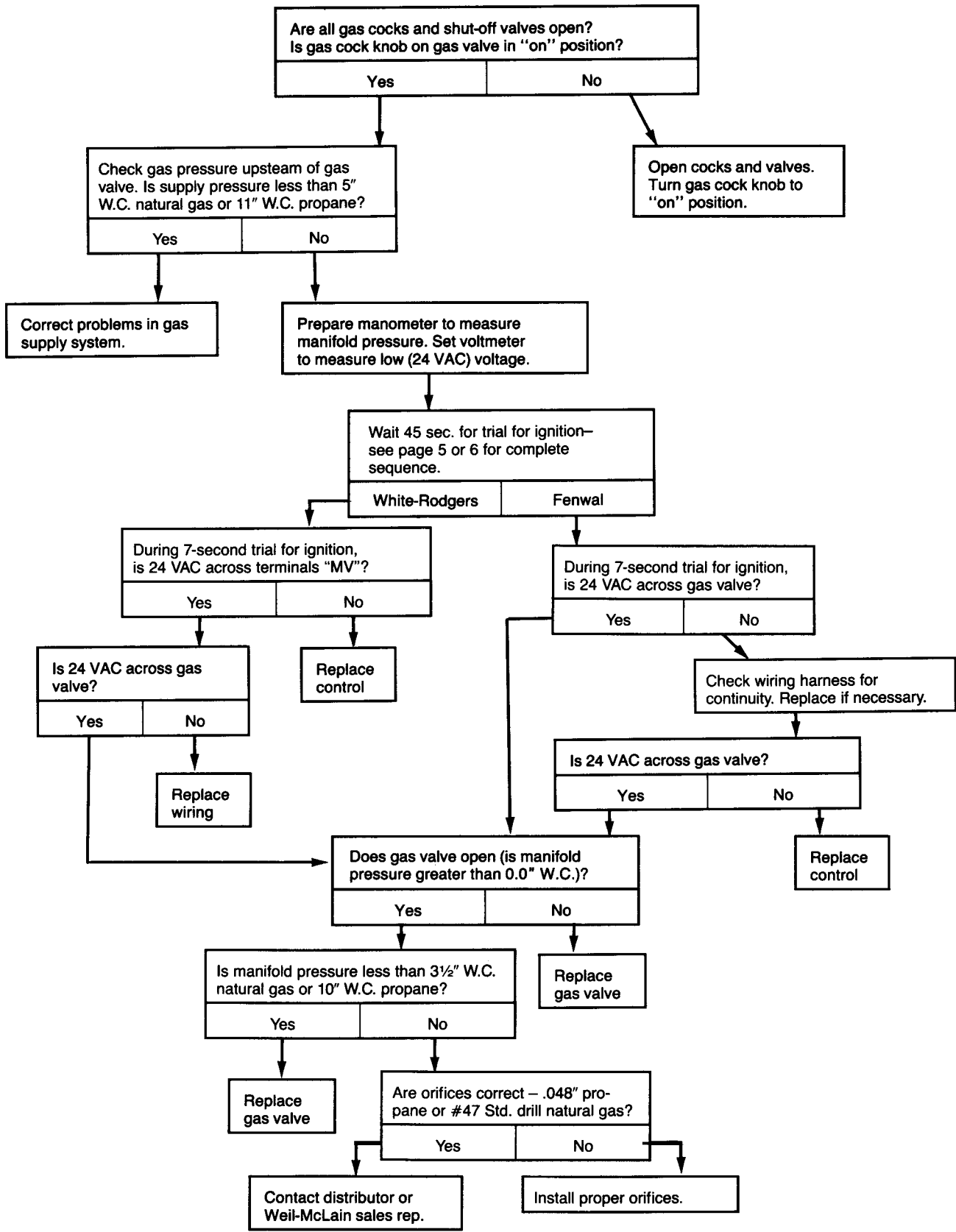
Check/replace ignitor and ignitor wiring

Replace ignition control after checking wiring harness continuity.

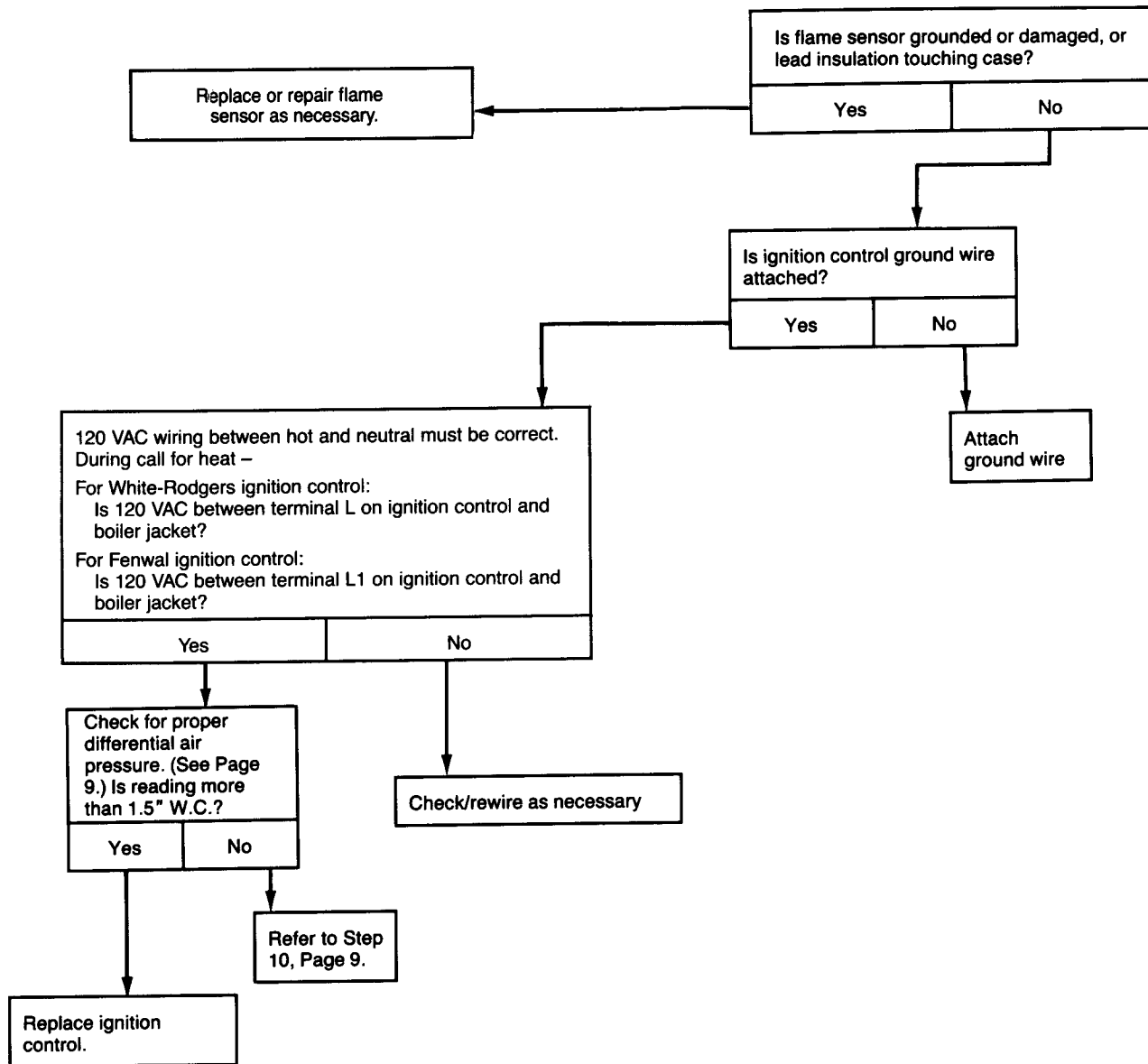


TABLE VI—IGNITOR GLOWS, MAIN BURNERS WILL NOT LIGHT

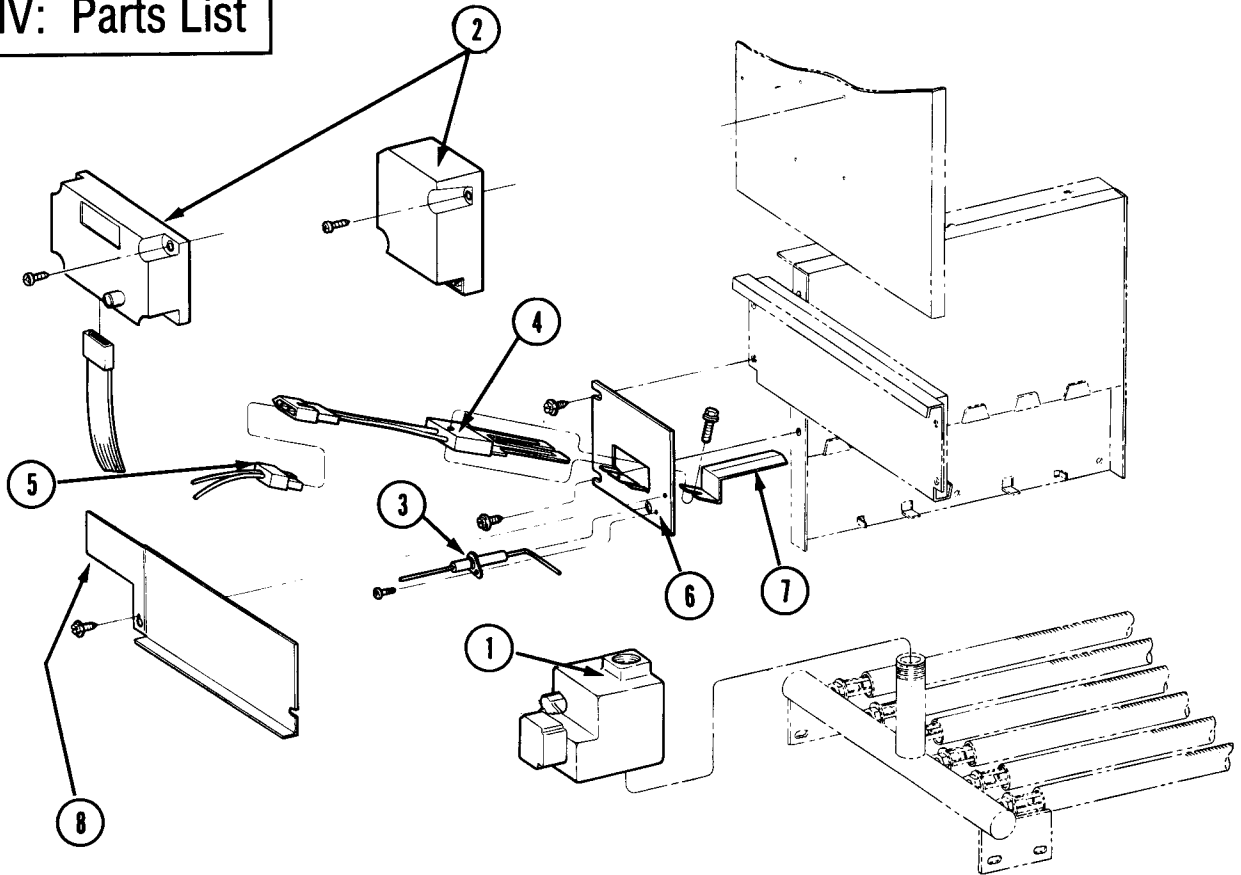
NAT. GAS OR PROPANE



**TABLE VII—IGNITOR GLOWS—MAIN BURNERS LIGHT, THEN SHUT DOWN—NAT. GAS & PROPANE**



# Section IV: Parts List



**NOTE: CONTROLS ARE INTERCHANGEABLE UNLESS OTHERWISE NOTED.**

FIG. NO.	PART DESCRIPTION	VENDOR/PART NUMBER	WEIL-McLAIN SALES REF. NO.
1	STEP-OPENING GAS VALVES: NATURAL  PROPANE	WHITE-RODGERS 36C74-215 HONEYWELL VR8450P2111 WR36E03-211 WHITE-RODGERS 36C74-227 HONEYWELL VR8450P2137	10C134■ 10C134■ 10C134■ 10C135■ 10C135■
<b>WHITE-RODGERS SYSTEM ONLY</b>			
2	IGNITION CONTROL	WHITE-RODGERS 50E47-170	10C182■
5	WIRING HARNESS	* WHITE-RODGERS F115-0100	10C329
3	FLAME SENSOR		
<b>FENWAL SYSTEM ONLY</b>			
2	IGNITION CONTROL	FENWAL 05-212226-103	10C181■
5	WIRING HARNESS	* WEIL-McLAIN	10C331
3	FLAME SENSOR		
4	IGNITOR REPLACEMENT KIT	WEIL-McLAIN	10C497
6	IGNITOR BRACKET	WEIL-McLAIN	10C500
7	IGNITOR SHIELD	WEIL-McLAIN	10B683
8	ACCESS PANEL-3	WEIL-McLAIN	10B685
	-4	WEIL-McLAIN	10B686
	-5	WEIL-McLAIN	10B687
	-6	WEIL-McLAIN	10B688
NOT SHOWN	T-TAP CONNECTOR	WEIL-McLAIN	10C498

\* Items are interchangeable as **groups** only.

■ Can be purchased at local supply house or distributor.

Weil-McLain Sales Ref. No. can be found in Weil-McLain Boilers and Controls Repair Parts Book.



Weil-McLain  
500 Blaine Street  
Michigan City, IN 46360-2388