

WEIL-McLAIN



HE and VHE (Series 3) Hot Surface Ignition (HSI) System

Control
Supplement

USING CONTROL SYSTEMS BY:
WHITE-RODGERS
FENWAL
HONEYWELL

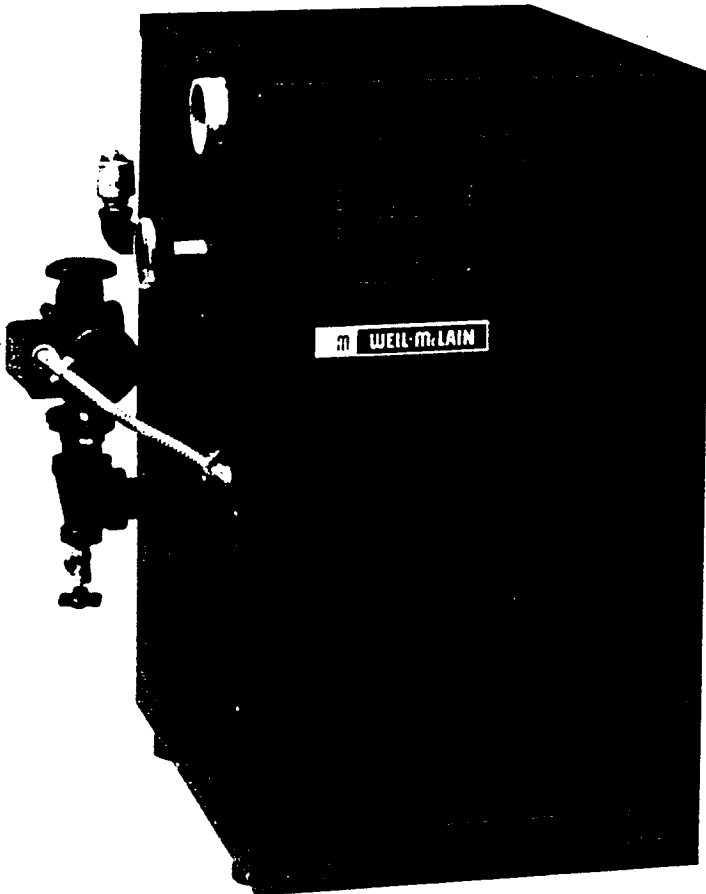

MODEL HE

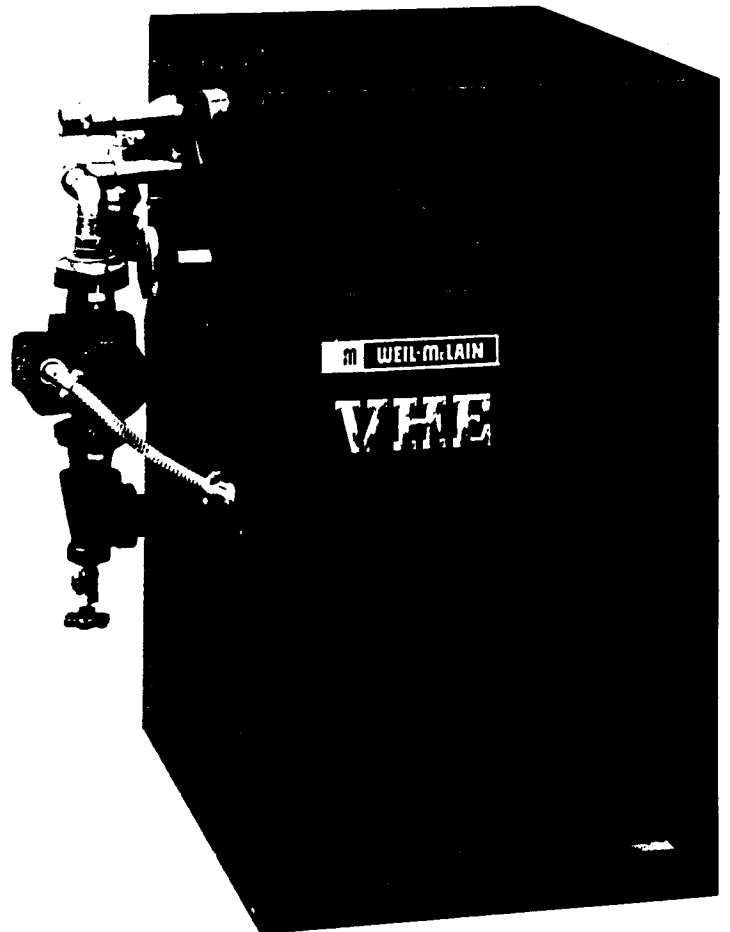

MODEL VHE

FOR NATURAL OR PROPANE
GAS-FIRED BOILERS

Table of Contents

Section I: Components 4

Section II: Sequence of Operation

White-Rodgers:	
Sequence of Operation	5
Wiring Diagram	5
Fenwal:	
Sequence of Operation	6
Wiring Diagram	6
Honeywell:	
Sequence of Operation	7
Wiring Diagram	7

Section III: Troubleshooting Procedure

Special Service Tips	8
Checking Pressure Differential Switch	9
Troubleshooting Guides	10-13

Section IV: Parts List

Parts Drawing	14
Parts List	15

IMPORTANT: When calling or writing about the boiler, PLEASE GIVE THE MODEL, SERIES, AND C.P. NUMBER, located on boiler rating plate.

Any reuse of reproduction of the artwork and copy in this manual is strictly prohibited without the written consent of Weil-McLain.

HOT SURFACE IGNITION SYSTEM (WHITE-RODGERS SYSTEM SHOWN)

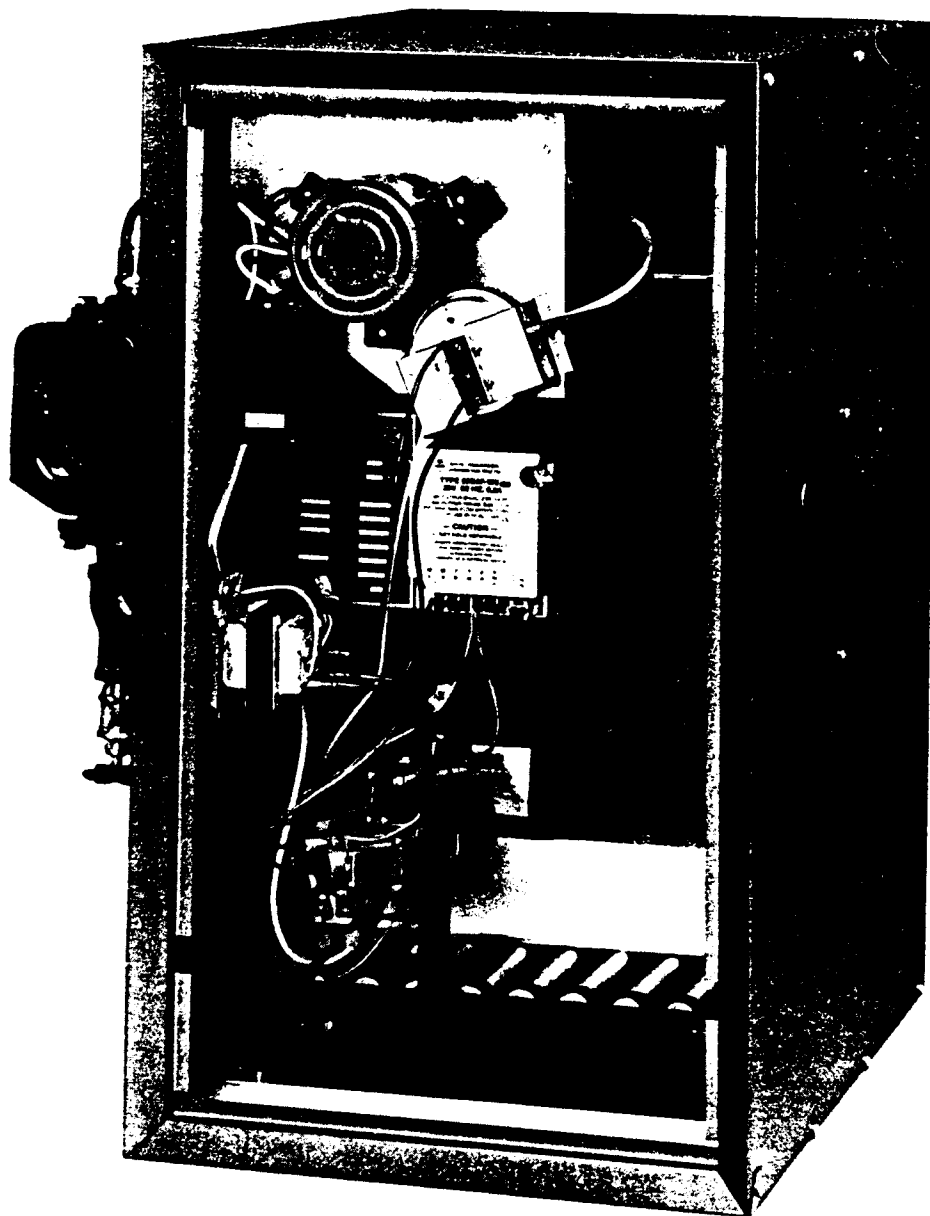

INDIVIDUAL COMPONENTS SHOWN ON PAGE 4

Section I: Components

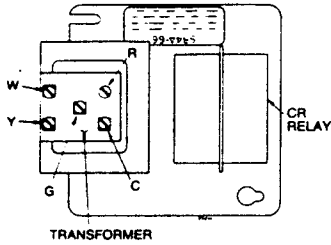

**120/24V 40 VA TRANSFORMER
AND DPST CIRCULATOR RELAY
FIGURE 1**

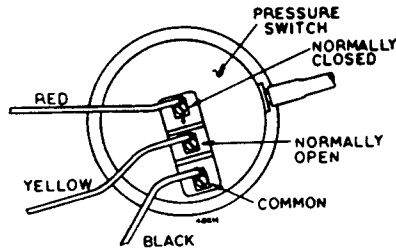

**PRESSURE SWITCH
FIGURE 2**

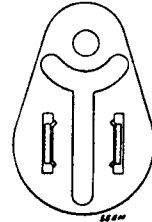

**THERMAL FUSE ELEMENT (TFE)
FIGURE 3**

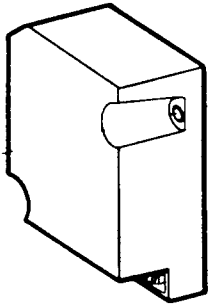

**WHITE-RODGERS IGNITION CONTROL
(Powers gas valve, ignitor,
and flame sensor)
FIGURE 4**

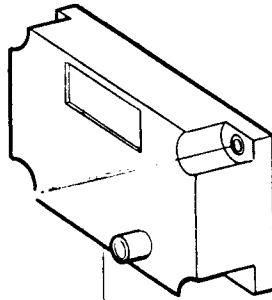

**FENWAL IGNITION CONTROL
(Powers gas valve and ignitor)
FIGURE 5**

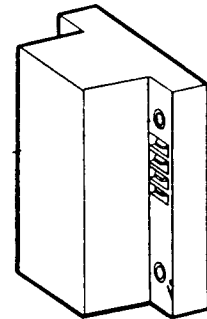

**HONEYWELL IGNITION CONTROL
(Powers gas valve and ignitor)
FIGURE 6**

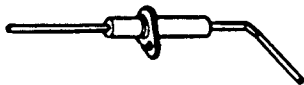

**WHITE-RODGERS FLAME SENSOR
(Used with W-R ignition control
to sense flame during main
burner run cycle)
FIGURE 7**

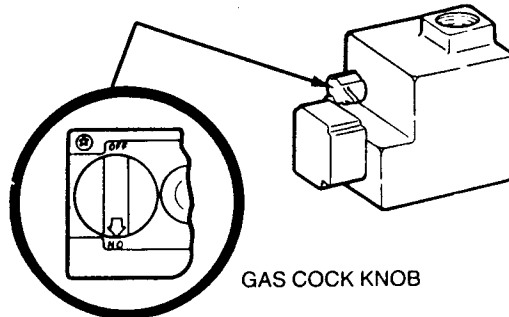

**GAS VALVE
(Incorporates redundant solenoid
valve, step-opening pressure
regulator, and main valve operator)
FIGURE 8**



**IGNITOR
(Heats to light main burners)
FIGURE 9**

Section II: Sequence of Operation

WHITE-RODGERS HOT SURFACE IGNITION SYSTEM

1. Thermostat closes, activating relay CR (through pressure switch).
 - a) CR2 activates: circulator blower through limit switch
 - b) CR1 provides by-pass around pressure switch to prove its operation.
2. Pressure switch proves safe air flow, and switches to NO position, allowing 24 VAC through TFE to ignition control.
3. 45-second igniter heat-up.
4. 7-second trial for ignition:
 - a) Valve opens—low fire position
 - b) Flame rectification proves.
 - c. Power to ignitor off.
 - d. Main valve switches to high fire position.
5. After thermostat is satisfied, CR is deactivated:
 - a) CR2 opens turning off blower and circulator.
 - b) CR1 opens turning off gas flow.
6. As air flow from blower reduces pressure, switch changes to normally closed position.
7. Boiler is now in "off" cycle.

SCHEMATIC WIRING DIAGRAM

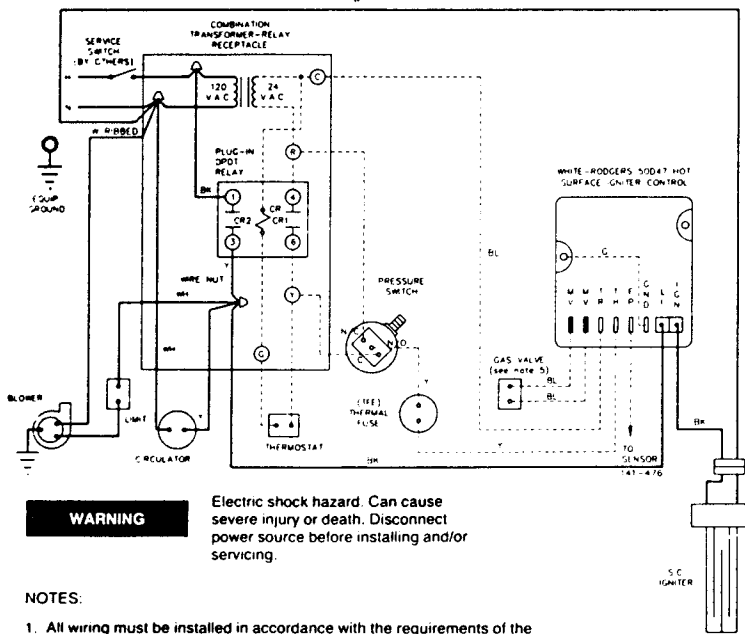

LADDER WIRING DIAGRAM

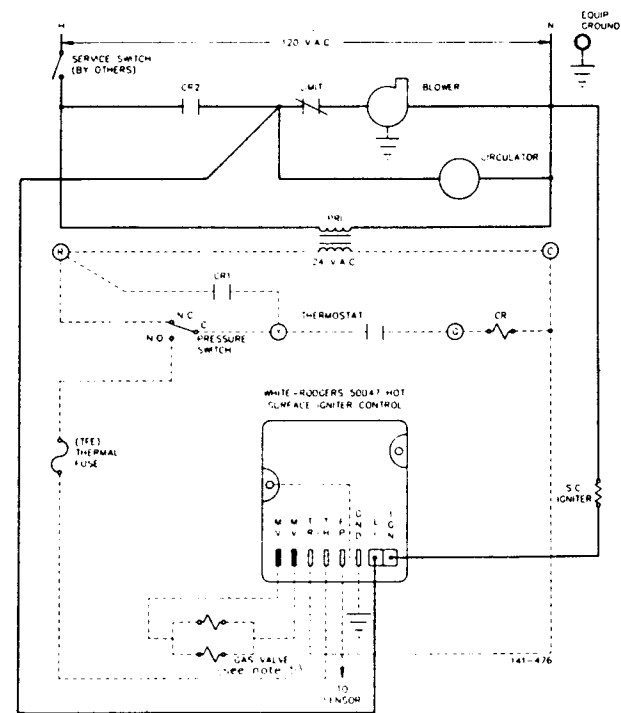

High Voltage _____
Low Voltage - - - - -

THERMOSTAT HEAT ANTICIPATOR SETTING		
SYSTEM	HE	VHE
WATER	0.40 AMPS	0.40 AMPS

HE and VHE Series 3 Schematic and Ladder Wiring Diagrams. WHITE-RODGERS Hot Surface Ignition System. Applicable for natural or propane gas-fired, forced hot water boilers.

WEIL-McLAIN
Michigan City, Indiana 46360
A Marley Company



FENWAL HOT SURFACE IGNITION SYSTEM

- Thermostat closes, activating relay CR (through pressure switch). Contacts CR1 and CR2 close:
 - CR2 activates: circulator
blower through limit switch
 - CR1 provides by-pass around pressure switch to prove its operation.
- Pressure switch proves safe air flow, and switches to NO position, allowing 24 VAC through TFE to ignition control.
- 45-second igniter heat-up.
- 6.8-second trial for ignition:
 - Valve opens—low fire position
 - Power to ignitor off.
 - Flame rectification proves.
 - Main valve switches to high fire position.
- After thermostat is satisfied, CR is deactivated:
 - CR2 opens turning off blower and circulator.
 - CR1 opens turning off gas flow.
- As air flow from blower reduces pressure, switch changes to normally closed position.
- Boiler is now in "off" cycle.

SCHEMATIC WIRING DIAGRAM

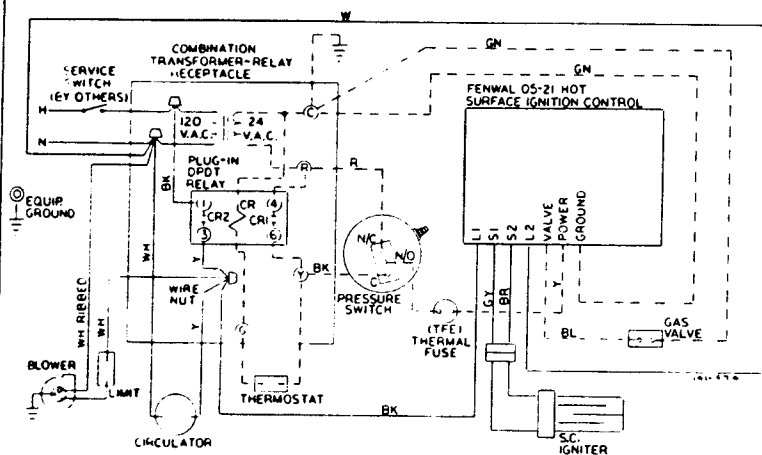

WARNING

Electric shock hazard. Can cause severe injury or death. Disconnect power source before installing and/or servicing.

NOTES

- All wiring must be installed in accordance with the requirements of the national electrical code and any additional state or local code requirements having jurisdiction.
- Refer to control component instruction sheets packed with boiler for application information.
- If any of the original wire must be replaced, use 90°C thermoplastic or equivalent.
- All safety circuit wiring must be N.E.C. Class 1.
- Gas valve terminals:
White-Rodgers—1 and 2
Honeywell—TR and TH.

THERMOSTAT HEAT ANTICIPATOR SETTING		
SYSTEM	HE	VHE
WATER	0.40 AMPS	0.40 AMPS

LADDER WIRING DIAGRAM

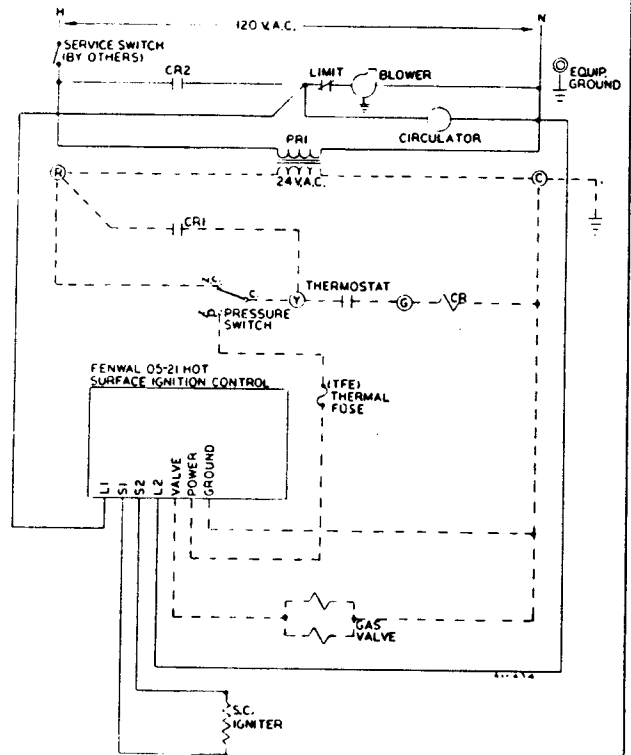

High Voltage _____
Low Voltage - - - - -

HE and VHE Series 3 Schematic and Ladder Wiring Diagrams.
FENWAL Hot Surface Ignition System. Applicable for natural or propane gas-fired, forced hot water boilers.

WEIL-McLAIN
Michigan City, Indiana 46360
A Marley Company

Part Number 550-141-474/0387WM

HONEYWELL HOT SURFACE IGNITION SYSTEM

1. Thermostat closes, activating relay CR (through pressure switch).
 - a) CR2 activates: circulator
blower through limit switch
 - b) CR1 provides by-pass around pressure switch to prove its operation.
2. Pressure switch proves safe air flow, and switches to NO position, allowing 24 VAC through TFE to igniter control.
3. 45-second igniter heat-up.
4. 6-second trial for ignition:
 - a) Valve opens—low fire position
 - b) Power to ignitor off.
 - c) Flame rectification proves.
 - d) Main valve switches to high fire position.
5. After thermostat is satisfied, CR is deactivated:
 - a) CR2 opens turning off blower and circulator.
 - b) CR1 opens turning off gas flow.
6. As air flow from blower reduces pressure, switch changes to normally closed position.
7. Boiler is now in "off" cycle.

SCHEMATIC WIRING DIAGRAM

LADDER WIRING DIAGRAM

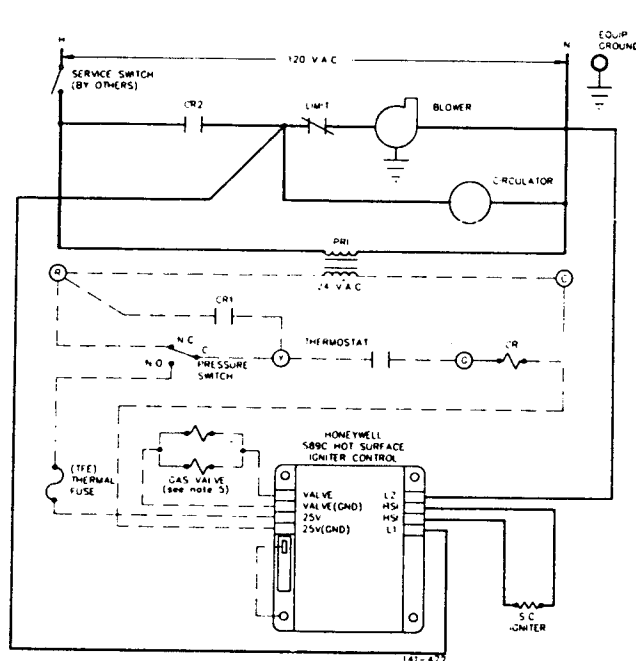
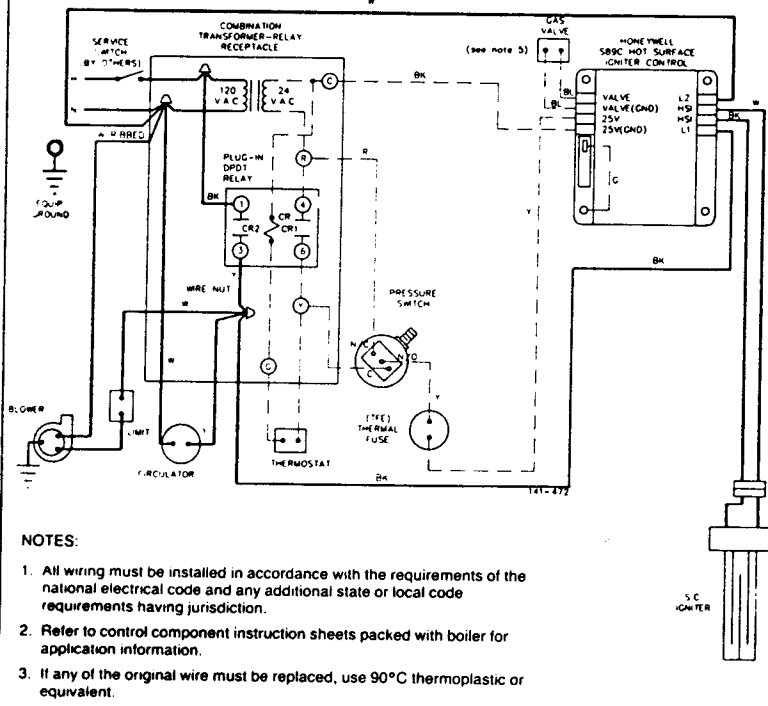

NOTES:

1. All wiring must be installed in accordance with the requirements of the national electrical code and any additional state or local code requirements having jurisdiction.
2. Refer to control component instruction sheets packed with boiler for application information.
3. If any of the original wire must be replaced, use 90°C thermoplastic or equivalent.
4. All safety circuit wiring must be N.E.C. Class 1.
5. Gas valve terminals:
White-Rodgers—1 and 2
Honeywell—TR and TH.

High Voltage _____
Low Voltage _____

WARNING

Electric shock hazard. Can cause severe injury or death. Disconnect power source before installing and/or servicing.

THERMOSTAT HEAT ANTICIPATOR SETTING		
SYSTEM	HE	VHE
WATER	0.40 AMPS	0.40 AMPS

HE and VHE Series 3 Schematic and Ladder Wiring Diagrams. HONEYWELL Hot Surface Ignition System. Applicable for natural or propane gas-fired, forced hot water boilers.

WEIL-McLAIN
Michigan City, Indiana 46360
A Marley Company



Section III: Troubleshooting Procedure

DANGER

NEVER jumper (by-pass) Thermal Fuse Element (TFE) or any other safety device (except for momentary testing as outlined in Trouble Shooting Tables). A fire causing property damage and/or personal injury could result.

CAUTION

Access panel must be in position during boiler operation to prevent momentary flame rollout on ignition of main flame, which can melt thermal fuse element. Never jumper thermal fuse.

A. Before trouble shooting:

1. Have a voltmeter capable of checking 120 VAC, 24 VAC and a continuity tester.
2. Is 120 VAC power supply available to the boiler (minimum 102 VAC, maximum 132 VAC)?
3. Is 24VAC at the secondary side of the control transformer?
4. Have an inclined manometer with a range of 0–2.0" W.C.

B. Visually check for following conditions:

1. Ignitor does not glow—see Tables I, II, & IV.
2. No main burner ignition—see Table V.
3. Main burners come on and drop out—see Table VI.

SPECIAL SERVICE TIPS

IGNITOR

1. Unplug ignitor and remove entire bracket assembly for service.
2. Ignitor is fragile. Handle with care.
3. Attach ignitor and ignitor shield to ignitor bracket before installing.

GAS VALVE

1. Install gas valve with arrow in direction of gas flow.

IGNITION CONTROL

1. Make sure ground wire is attached per wiring diagram. Good grounding is extremely important for proper flame rectification.

CHECKING THE PRESSURE DIFFERENTIAL SWITCH

NOTE: Make sure boiler water temperature is 100°F. or cooler before beginning procedure.

1. Remove sensing tube at front of pressure switch (closest to you as you face the boiler).
2. Install a "T" into sensing tube. Run another piece of tubing from the "T" to the pressure switch.
3. Attach third leg of the "T" to suction side of an inclined manometer.
4. Remove sensing tube at the rear of pressure switch.
5. Install a "T" into sensing tube. Run another piece of tubing from the "T" to the pressure switch.
6. Attach third leg of the "T" to pressure side of the manometer.
7. Close manual main gas valve and set thermostat to call for heat. Blower will run but main burners will not ignite.
8. Check for 24 VAC between normally open terminal on pressure switch and terminal C on transformer (Figures 1 and 2).
9. If manometer reading is at least 1.5 inches water column pressure, but there is not 24 V across N.O. terminal on pressure switch and terminal C, replace pressure switch.
10. If reading is lower than 1.5" W.C. look for the following causes:
 - a) Blockage in sensing tube.
 - b) Obstruction in blower housing outlet.
 - c) Loose blower wheel on motor shaft.
 - d) Blower motor not at proper RPM.
 - e) Blower back plate not sealed properly.
 - f) Blockage in block assembly.
 - g) Blockage in flue pipe or termination.
11. When pressure reading is proper and pressure switch is operating properly, remove "T"s and re-install sensing tubes to the pressure switch. Reset system by turning on and off main electrical switch.

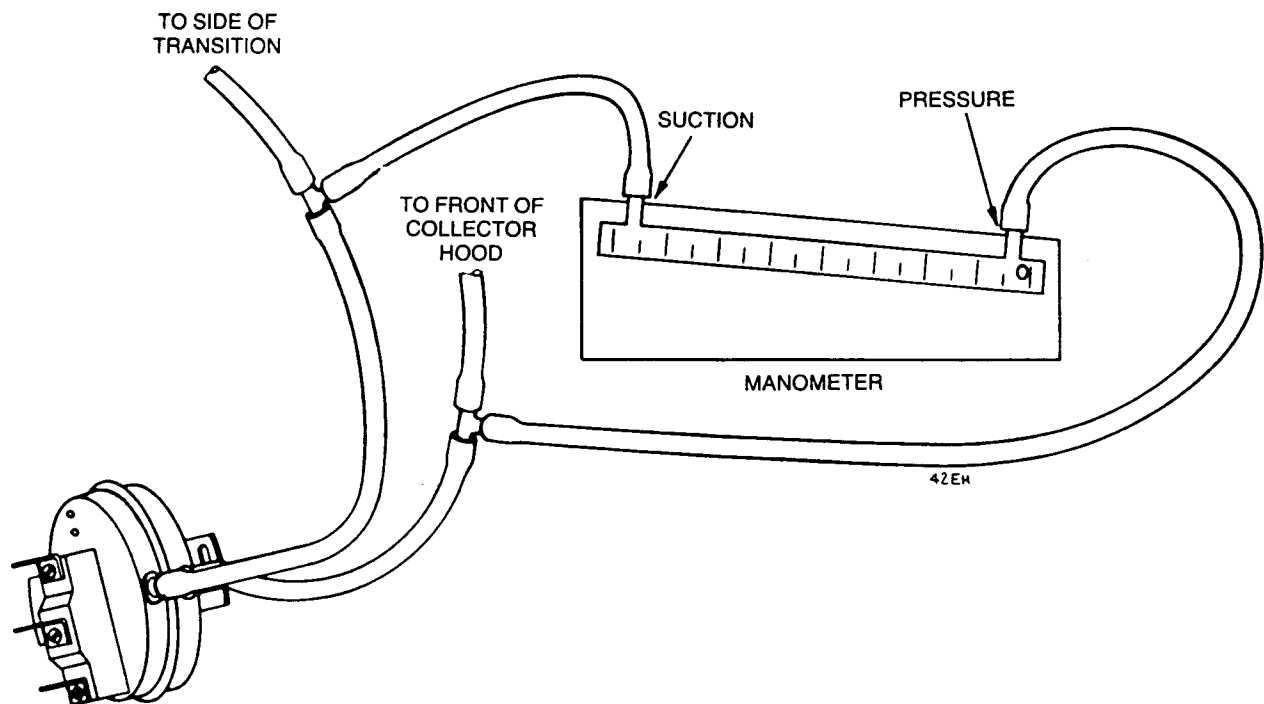
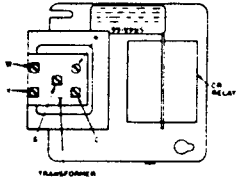

FIGURE 10

TROUBLE SHOOTING GUIDES

TABLE I—BLOWER AND CIRCULATOR WILL NOT OPERATE



**TRANSFORMER
FIGURE 1**

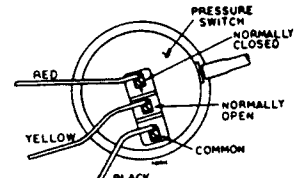

**PRESSURE SWITCH
FIGURE 2**

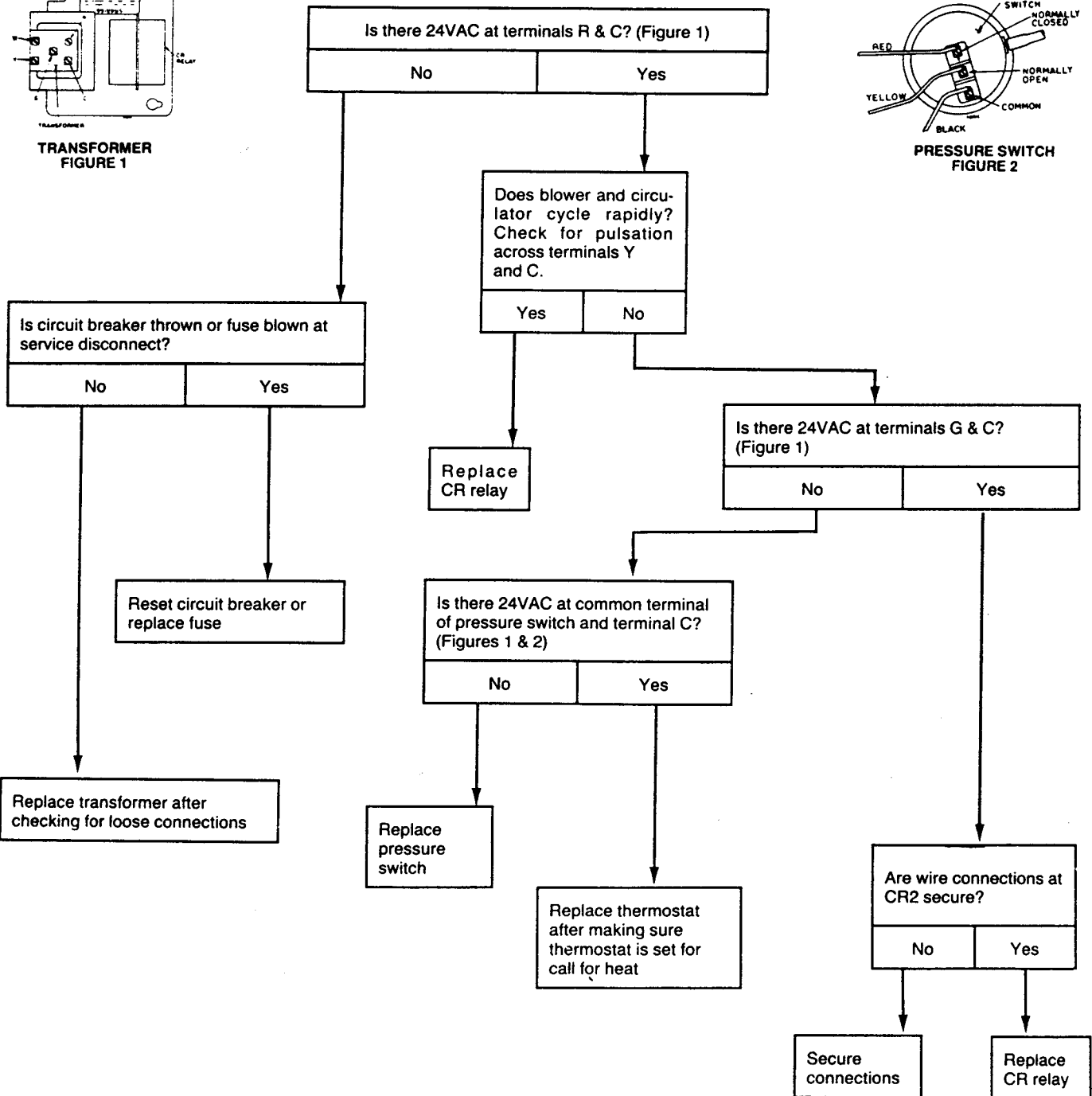

TABLE II—BLOWER WILL NOT OPERATE, BUT CIRCULATOR DOES OPERATE

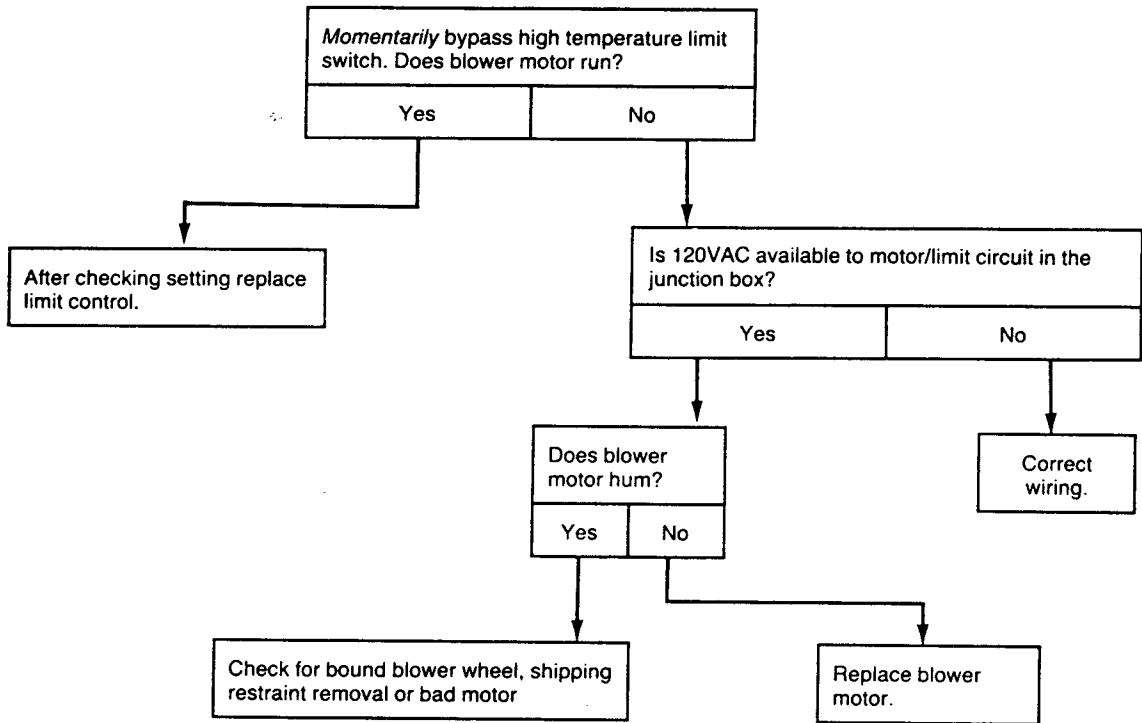

TABLE III—CIRCULATOR WILL NOT OPERATE, BUT BLOWER DOES OPERATE

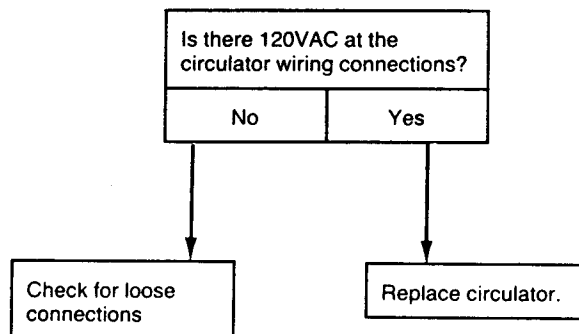
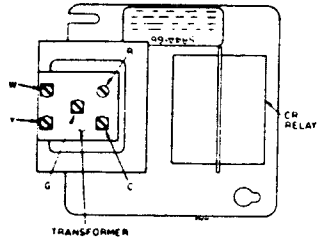
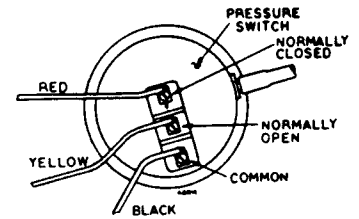

TABLE IV—IGNITOR WILL NOT GLOW—BLOWER & CIRCULATOR BOTH OPERATE

NOTE: CHECK FOR LOCKOUT BEFORE PROCEEDING. OPEN THERMOSTAT, THEN CLOSE FOR NEW CALL FOR HEAT.



120/24V 40 VA
TRANSFORMER AND DPST
CIRCULATOR RELAY
FIGURE 1



PRESSURE SWITCH
FIGURE 2

Is 24VAC between Terminal C on relay/transformer (Figure 1) and normally open contact on air pressure switch? (Figure 2)	
Yes	No

Check for proper differential air pressure. Is reading more than 1.5" W.C.?	
Yes	No

Is 24VAC present between Terminal C on relay/transformer (Figure 1) and each terminal on TFE? (Figure 3)	
No	Yes

Replace pressure switch.

Refer to Step 10, Page 9 and correct problem.

Check wiring then replace TFE

WARNING
NEVER JUMPER OUT (BY-PASS) TFE

For White-Rodgers ignition control: Is 24VAC across Terminals TH & TR on ignition control and line voltage across Terminal IGN and ground on case? For Fenwal Ignition control: Disconnect harness from control. At harness plug, is 24VAC across "power" (yellow) and "ground" (green) and line voltage across "L1" (black) and "L2" (white)? For Honeywell Ignition control: Is 24VAC across Terminals 25V and 25V (Grnd) on ignition control and line voltage across Terminals L1 and L2?	
Yes	No

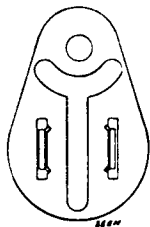

THERMAL FUSE ELEMENT (TFE)
FIGURE 3

Check wiring.

Is line voltage across terminals at moxex plug from control to ignitor?	
Yes	No

Check/replace ignitor and ignitor wiring

Replace ignition control after checking wiring harness continuity.

TABLE V—IGNITOR GLOWS, MAIN BURNERS WILL NOT LIGHT

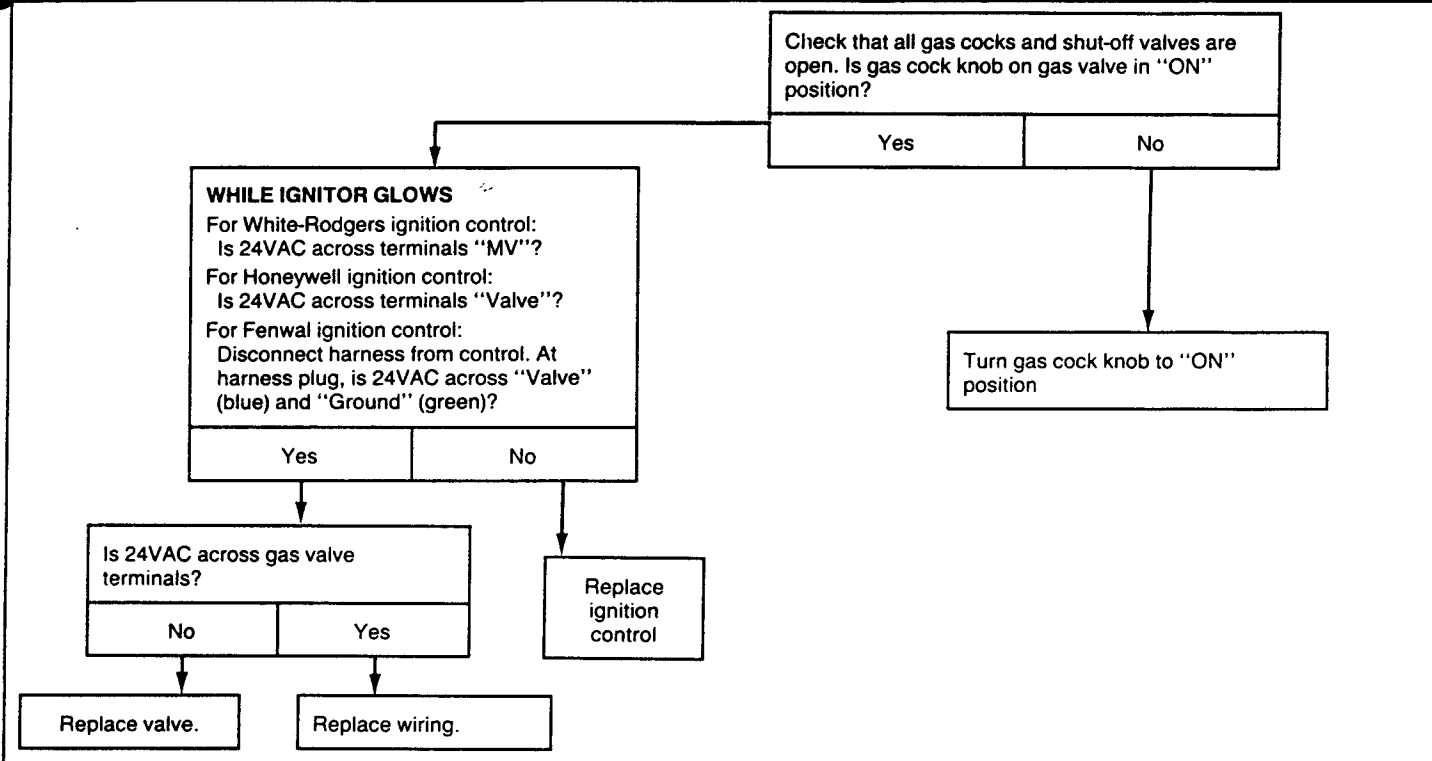
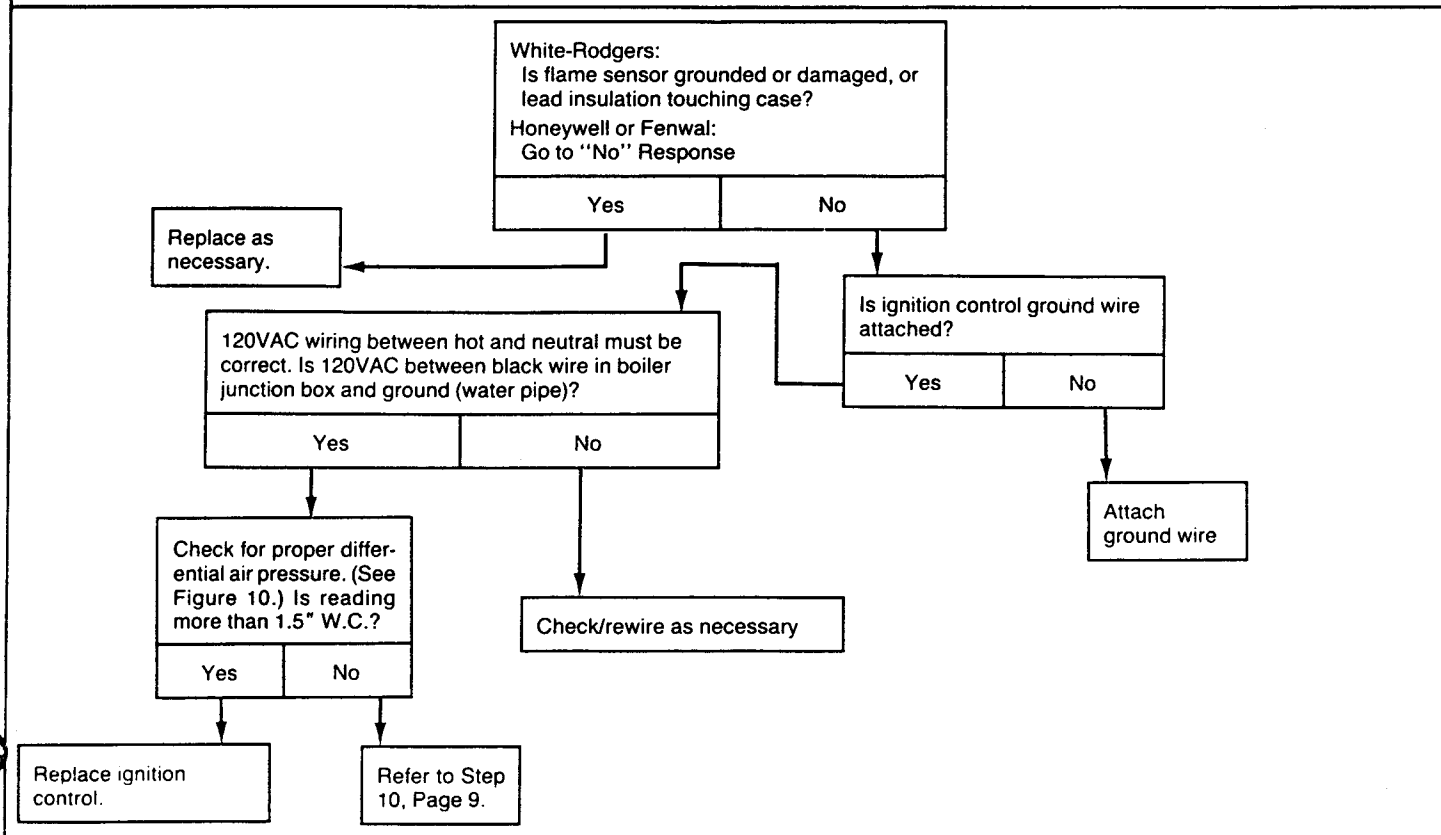
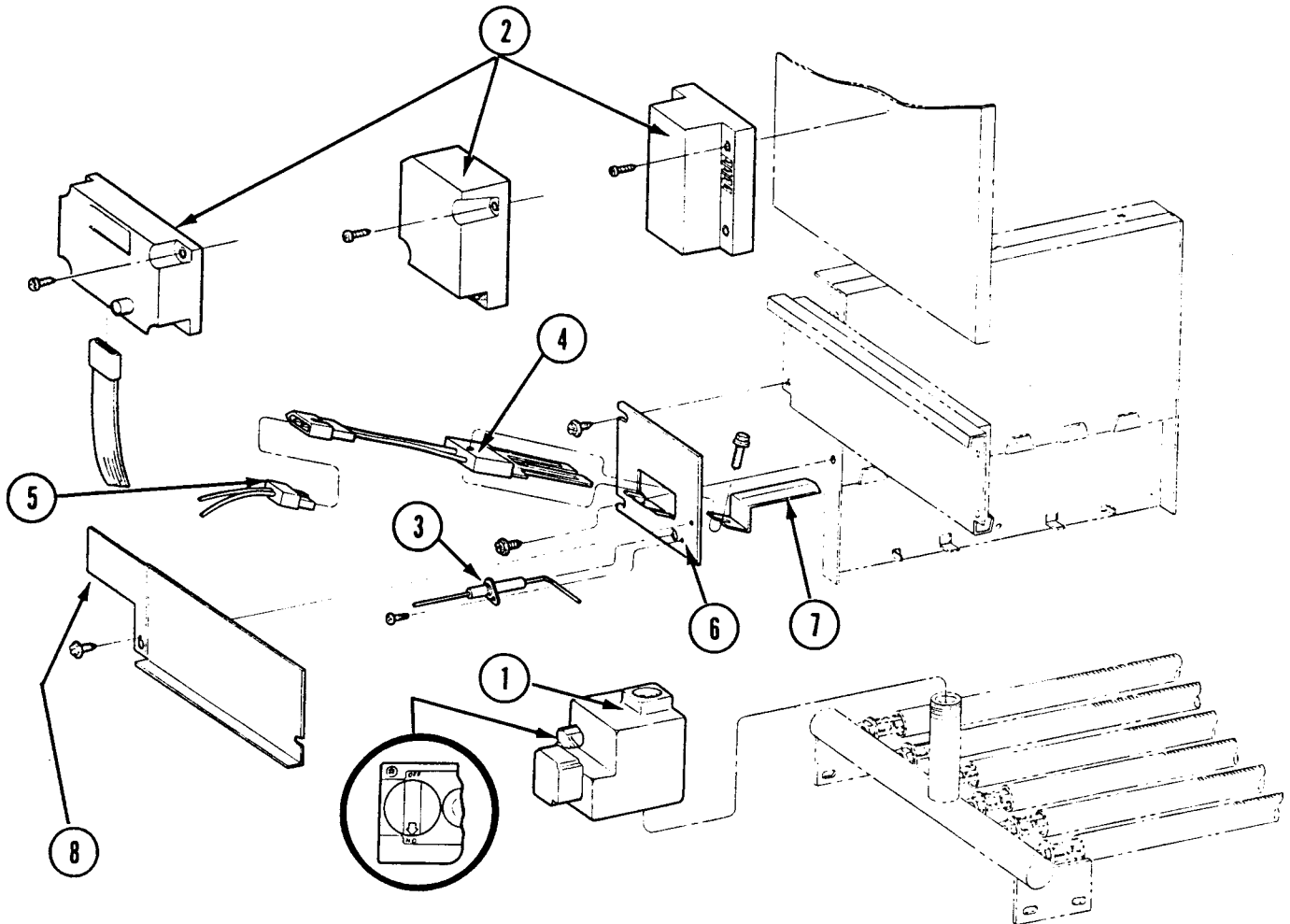

TABLE VI—IGNITOR GLOWS—MAIN BURNERS LIGHT, THEN SHUT DOWN



Section IV: Parts List



GAS COCK KNOB

PARTS LIST

NOTE: CONTROLS ARE INTERCHANGEABLE UNLESS OTHERWISE NOTED.

FIG. NO.	PART DESCRIPTION	VENDOR/PART NUMBER	WEIL-McLAIN PART NUMBER	
1	STEP-OPENING GAS VALVES: NATURAL PROPANE	WHITE-RODGERS 36C74-215	511-044-320 ■	
		HONEYWELL VR8450P2111	511-044-315 ■	
		WHITE-RODGERS 36C74-227	511-044-323 ■	
		HONEYWELL VR8450P2137	511-044-324 ■	
2	IGNITION CONTROL	WHITE-RODGERS 50D47-170	511-330-129 ■	
3	FLAME SENSOR	* WHITE-RODGERS 760-802	511-330-192 ■	
5	WIRING HARNESS		WHITE-RODGERS F115-0100	591-391-808
2	IGNITION CONTROL		FENWAL 05-212226-103	511-330-128 ■
5	WIRING HARNESS	* WEIL-McLAIN	591-391-810	
2	IGNITION CONTROL	HONEYWELL S89C1004	511-330-127 ■	
5	WIRING HARNESS	* WEIL-McLAIN	591-391-809	
4	IGNITOR	WHITE-RODGERS 767A-350	511-330-191 ■	
		NORTON 201	511-330-190	
6	IGNITOR BRACKET	WEIL-McLAIN	450-030-643	
7	IGNITOR SHIELD	WEIL-McLAIN	450-030-642	
8	ACCESS PANEL—3	WEIL-McLAIN	450-030-644	
	—4	WEIL-McLAIN	450-030-645	
	—5	WEIL-McLAIN	450-030-646	
	—6	WEIL-McLAIN	450-030-647	

- * Items are interchangeable as **groups** only. Flame sensor is only used with White-Rodgers.
- Can be purchased at local supply house or distributor.