

# WEIL-McLAIN

MODELS HE AND VHE®  
(Series 3)  
NATURAL GAS—FIRED  
INDUCED DRAFT BOILERS

**SUPPLEMENTAL  
INSTRUCTIONS**  
WITH WHITE-RODGERS  
CYCLE-PILOT® SYSTEM FOR  
NATURAL GAS-FIRED BOILERS  
—for use by a certified contractor



MODEL HE



MODEL VHE®

# NATURAL GAS

## TABLE OF CONTENTS

Base Assembly Parts Description With White-Rodgers Cycle-Pilot® For Natural Gas Firing .....	2
Ignition System Components .....	3
Boiler Equipment Components .....	4
Sequence of Operation .....	4
Schematic Wiring Diagram .....	5
Ladder Wiring Diagram .....	5
Trouble Shooting Procedure .....	6
Checking The Pressure Differential Switch .....	6
Trouble Shooting Charts .....	7-11

### HE and VHE® Base Assembly Parts Description With White-Rodgers Cycle-Pilot® For Natural Gas Firing

FIGURE	MODEL NO.	HE & VHE 3		HE & VHE 4		HE & VHE 5		HE & VHE 6	
NO.	PART DESCRIPTION	QTY.	PART NO.	QTY.	PART NO.	QTY.	PART NO.	QTY.	PART NO.
3	Relite Control	1	511-330-111	1	511-330-111	1	511-330-111	1	511-330-111
7	Gas Valve Assembly	1	511-044-288	1	511-044-288	1	511-044-288	1	522-044-288
8	Pilot Burner Assembly	1	511-330-235	1	511-330-235	1	511-330-235	1	511-330-235
11	Mercury Flame Sensor	1	511-724-262	1	511-724-262	1	511-724-262	1	511-724-262
■	Orifice, Main Burner Natural Gas No. 47 Drill	4	560-528-992	6	560-528-992	8	560-528-992	10	560-528-992

■ Not Shown

**NOTE: PARTS LISTED ABOVE ARE FOR BOILERS FIRED WITH NATURAL GAS ONLY. FOR ADDITIONAL PARTS COMMON TO NATURAL AND PROPANE GASES REFER TO BOILER MANUAL.**

**IMPORTANT: When calling or writing about the boiler, PLEASE GIVE THE MODEL, SERIES, AND C.P. NUMBER located on the boiler.**

**Any reuse or reproduction of the artwork and copy in this manual is strictly prohibited without the written consent of Weil-McLain.**

**HE and VHE®  
WHITE-RODGERS CYCLE—PILOT® IGNITION SYSTEM COMPONENTS  
FOR NATURAL GAS FIRING**

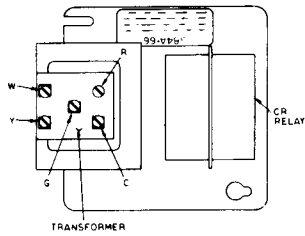

**TRANSFORMER  
FIGURE 1**

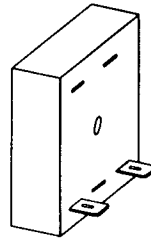

**PRE-PURGE TIMER  
FIGURE 5**

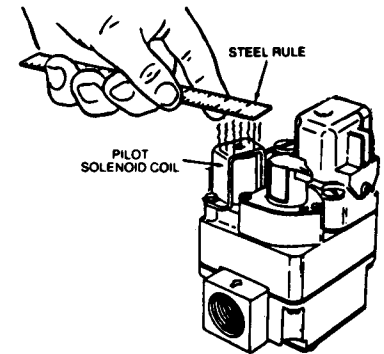

**CHECKING FOR ENERGIZED PILOT SOLENOID COIL. MAGNETIC PULL MEANS COIL IS "ON".  
FIGURE 9**

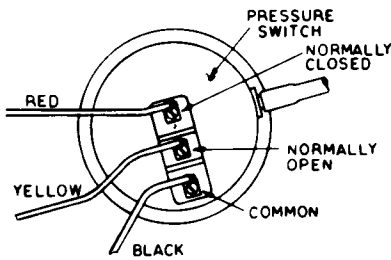

**PRESSURE SWITCH  
FIGURE 2**

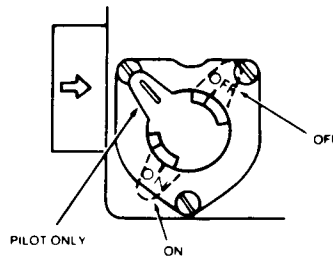

**NOTE:** When gas cock is positioned over black line on collar around knob, pilot will cycle on and off but main burner gas will not flow.

**36C84 GAS COCK KNOB  
FIGURE 6**

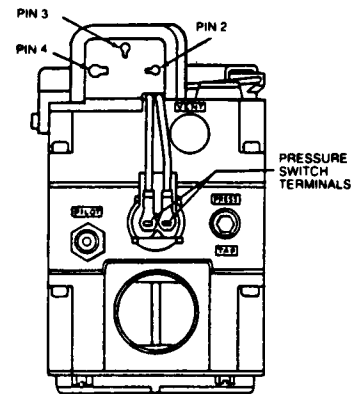

**FLAME SENSOR SOCKET  
FIGURE 10**

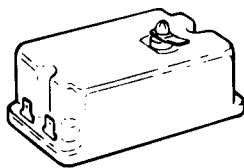

**5059 RELITE CONTROL  
FIGURE 3**

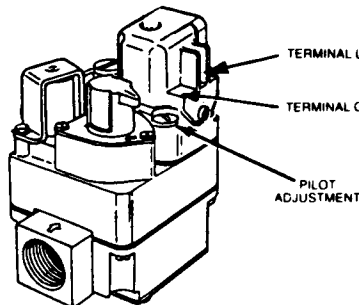

**36C84 GAS VALVE  
FIGURE 7**

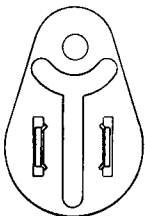

**THERMAL FUSE ELEMENT (TFE)  
FIGURE 4**

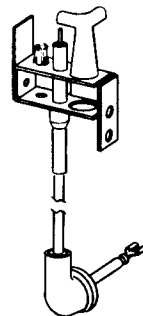

**E50 PILOT BURNER ASSY.  
FIGURE 8**

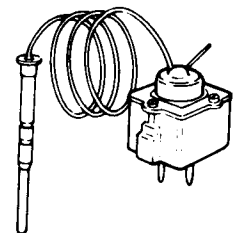

**3098 MERCURY FLAME SENSOR  
FIGURE 11**

**DANGER**

Never jumper the thermal fuse element. A fire causing personal injury and/or property damage could result.

---

# Operation, Wiring Diagrams, Trouble Shooting

---

## HE and VHE<sup>®</sup> With White-Rodgers Cycle-Pilot<sup>®</sup> For Natural Gas Firing

---

### BOILER EQUIPMENT COMPONENTS

#### BLOWER MOTOR

Provides rotation of induced draft fan.

#### FAN (BLOWER WHEEL)

Develops induced draft to supply combustion air to boiler.

#### PRE-PURGE TIMER

Provides 30 second pre-purge prior to pilot ignition.

#### HIGH TEMPERATURE LIMIT CONTROL

In the event of high boiler water temperature, shuts down fan and burners but allows circulator to run as long as there is a call for heat from thermostat.

#### PRESSURE SWITCH

Detects pressure differential across fixed metering orifice to prove air flow through boiler.

#### COMBINATION RELAY RECEPTACLE, JUNCTION BOX AND TRANSFORMER

120/24 VOLT 40 VA transformer provides low voltage for control circuit. Relay receptacle for plug-in circulator relay. Terminal strip for control circuit wiring.

#### PLUG-IN CIRCULATOR RELAY

Provides contact to energize circulator and fan and contact to prove operation of pressure switch.

#### GAS VALVE

Incorporates a pilot/redundant solenoid valve, integral pressure switch to sense incoming gas pressure, pressure regulator, main valve operator and socket to accept plug-in Mercury Flame Sensor.

#### MERCURY FLAME SENSOR

Consists of sensing bulb, capillary tube and diaphragm filled with mercury and connected to SPDT switch. Heat from pilot vaporizes mercury causing diaphragm to snap switch.

#### RELITE CONTROL

Provides spark to light pilot.

#### PILOT BURNER ASSEMBLY

Includes spark ignition pilot with mercury flame sensing probe.

#### THERMAL FUSE ELEMENT (TFE)

Provides safety shutdown of burners and pilot if flame is not contained in firebox.

#### CIRCULATOR

Provides forced water circulation to hot water heating system.

### SEQUENCE OF OPERATION

Refer to Ladder Diagram, Page 5.

1. Thermostat closes, activating relay CR (through pressure switch). Contacts CR1 and CR2 close:
  - a) CR2 activates circulator.
  - b) Blower is activated through limit switch.
  - c) CR1 provides a bypass around pressure switch to prove its operation.
2. When adequate draft is proven by pressure switch, 30 second pre-purge timer starts.
3. After a 30 second delay, 24 VAC is provided to terminals:
  - a) T2 on relite control which starts spark.
  - b) L on gas valve which opens pilot valve.
4. Pilot ignites:
  - a) Flame conduction stops spark from relite.
  - b) Mercury flame sensor opens main gas valve and pressure switch in gas valve holds pilot open.
5. After thermostat is satisfied, CR is deactivated:
  - a) CR2 opens turning off blower and pump.
  - b) CR1 opens turning off gas flow.
6. As air flow from blower reduces pressure, switch changes to normally closed position.
7. Boiler is now in "off" cycle.

## SCHEMATIC WIRING DIAGRAM

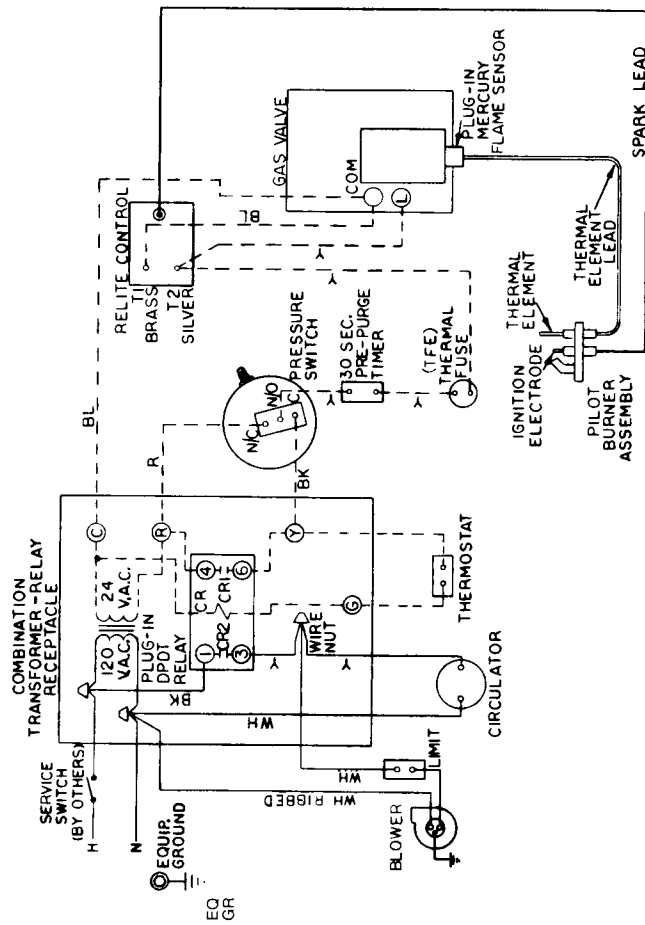

### WARNING

Electric shock hazard. Can cause severe injury or death. Disconnect power source before installing or servicing.

Burner access shield must be in position during boiler operation to prevent excessive delay in proving pilot (2 minutes or more) and/or a momentary flame roll-out on main flame ignition, which can melt the thermal fuse. NEVER jumper the thermal fuse or a hazardous condition will exist.

### NOTES:

1. All wiring must be installed in accordance with the requirements of the National Electrical Code and any additional national, state, or local code requirements having jurisdiction.
2. All safety circuit wiring must be N.E.C. Class 1.
3. Refer to Control Components Instructions Sheets packed with the boiler for application information.
4. Use only 90° C. Thermoplastic Wire, or equivalent, if any of the original wire must be replaced.

## LADDER WIRING DIAGRAM

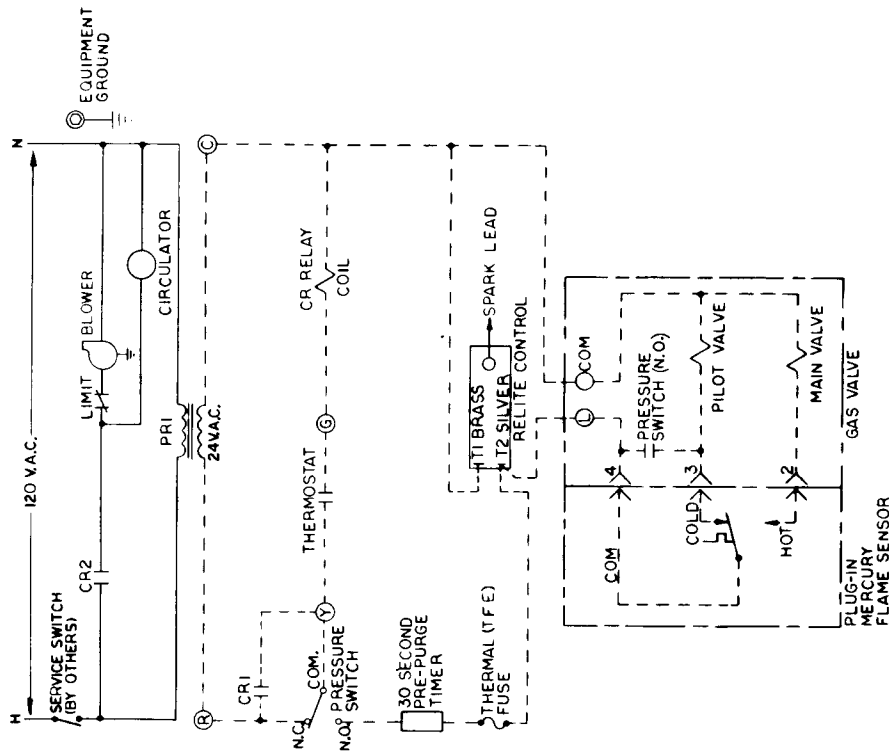

—— HIGH VOLTAGE      - - - - LOW VOLTAGE

THERMOSTAT HEAT ANTICIPATOR SETTING	
SYSTEM	HE and VHE
WATER	0.40 AMPS.

HE and VHE—White Rodgers Cycle-Pilot®—Boiler Schematic and Ladder Diagrams. Applicable for forced hot water boilers.

NATURAL GAS ONLY

# WEIL-McLAIN®

Michigan City, Indiana 46360  
A Marley Company

## TROUBLE SHOOTING PROCEDURE

### DANGER

**NEVER** jumper (by-pass) Thermal Fuse Element (TFE) or any other safety device (except for momentary testing as outlined in Trouble Shooting Tables). A fire causing property damage and/or personal injury could result.

### CAUTION

Access panel must be in position during boiler operation to prevent one or both of the following:

- A) Excessive delay in proving pilot (2 minutes or more)
  - B) A momentary flame rollout on ignition of main flame, which can melt the thermal fuse element.
- Never jumper the thermal fuse.

#### A. Before trouble shooting:

1. Have a voltmeter capable of checking 120 VAC, 24 VAC and a continuity tester.
2. Is 120 VAC power supply is available to the boiler (minimum 102 VAC, maximum 132 VAC)?
3. Is 24 VAC at the secondary side of the control transformer?
4. Have an inclined manometer with a range of 0-2.0" W.C.

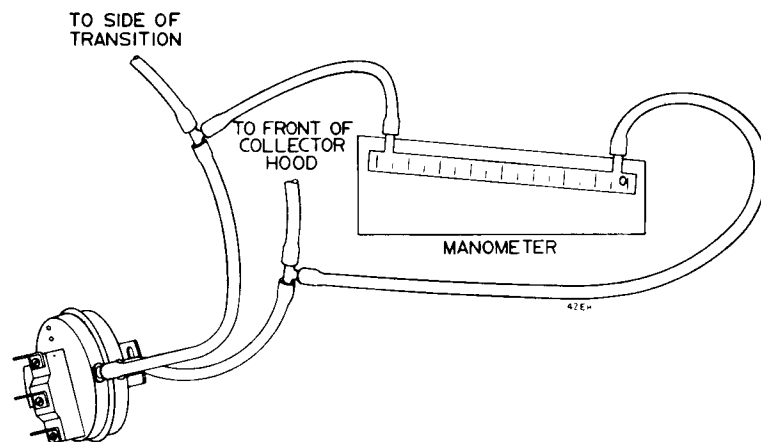

FIGURE 12

### CHECKING THE PRESSURE DIFFERENTIAL SWITCH

**Note:** Make sure boiler water temperature is 100°F or cooler before beginning procedure.

1. Remove sensing tube at front of pressure switch (closest to you as you face the boiler). Refer to Figure 12.
2. Install a "T" into sensing tube. Run another piece of tubing from the "T" to the pressure switch.
3. Attach third leg of the "T" to suction side of an inclined manometer.
4. Remove sensing tube at the rear of pressure switch.
5. Install a "T" into sensing tube. Run another piece of tubing from the "T" to the pressure switch.
6. Attach third leg of the "T" to pressure side of the manometer.
7. Close manual main gas valve and set thermostat to call for heat. Blower will run but pilot and main burners will not ignite.
8. Check for 24 VAC between normally open terminal on pressure switch and terminal C on transformer (Figure 1 and 2).
9. If manometer reading is at least 1.5 inches water column pressure, but there is not 24 V across N.O. terminal on pressure switch and terminal C, replace pressure switch.
10. If reading is lower than 1.5" W.C. look for the following causes:
  - a. Blockage in sensing tube.
  - b. Obstruction in blower housing outlet.
  - c. Loose blower wheel on motor shaft.
  - d. Blower motor not at proper RPM.
  - e. Blower back plate not sealed properly.
  - f. Blockage in block assembly.
  - g. Blockage in flue pipe or termination.
11. When pressure reading is proper and pressure switch is operating properly, remove "T"'s and re-install sensing tubes to the pressure switch.

TABLE I—BLOWER AND CIRCULATOR WILL NOT OPERATE

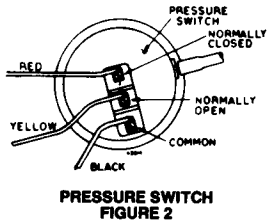
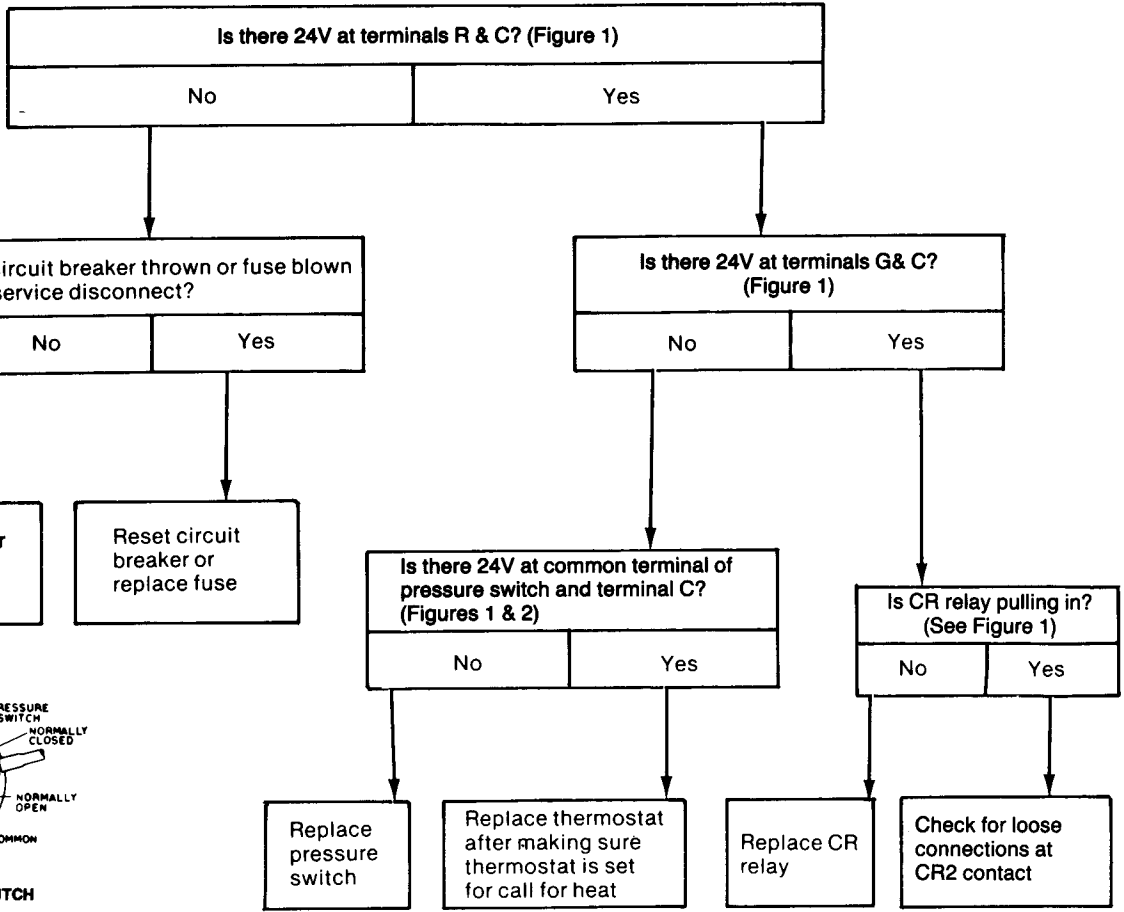
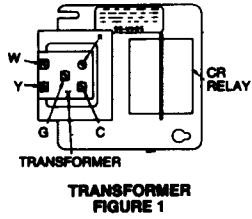

TABLE II—BLOWER WILL NOT OPERATE, BUT CIRCULATOR DOES OPERATE

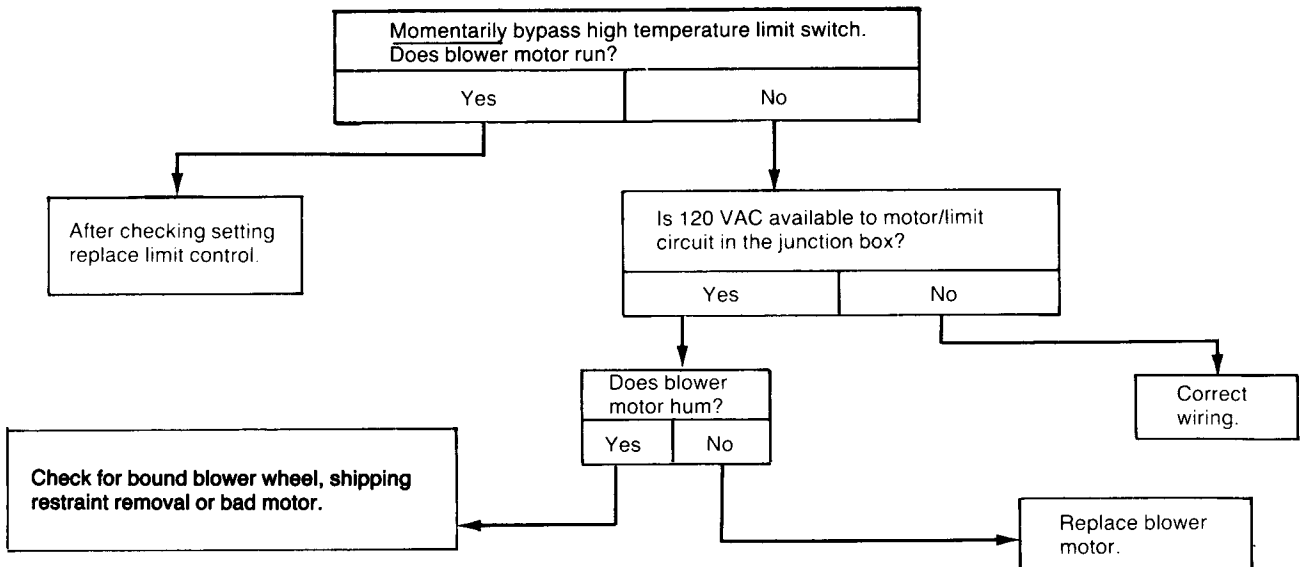

TABLE III—CIRCULATOR WILL NOT OPERATE, BUT BLOWER DOES OPERATE

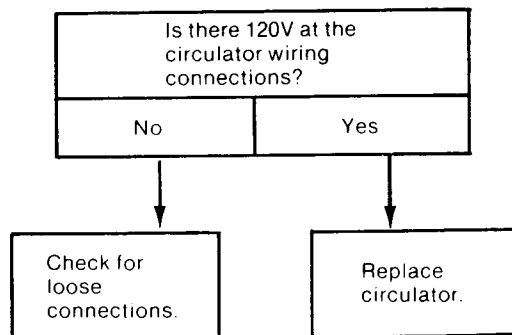
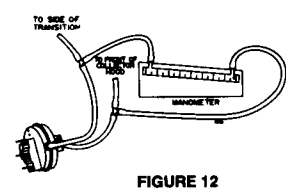
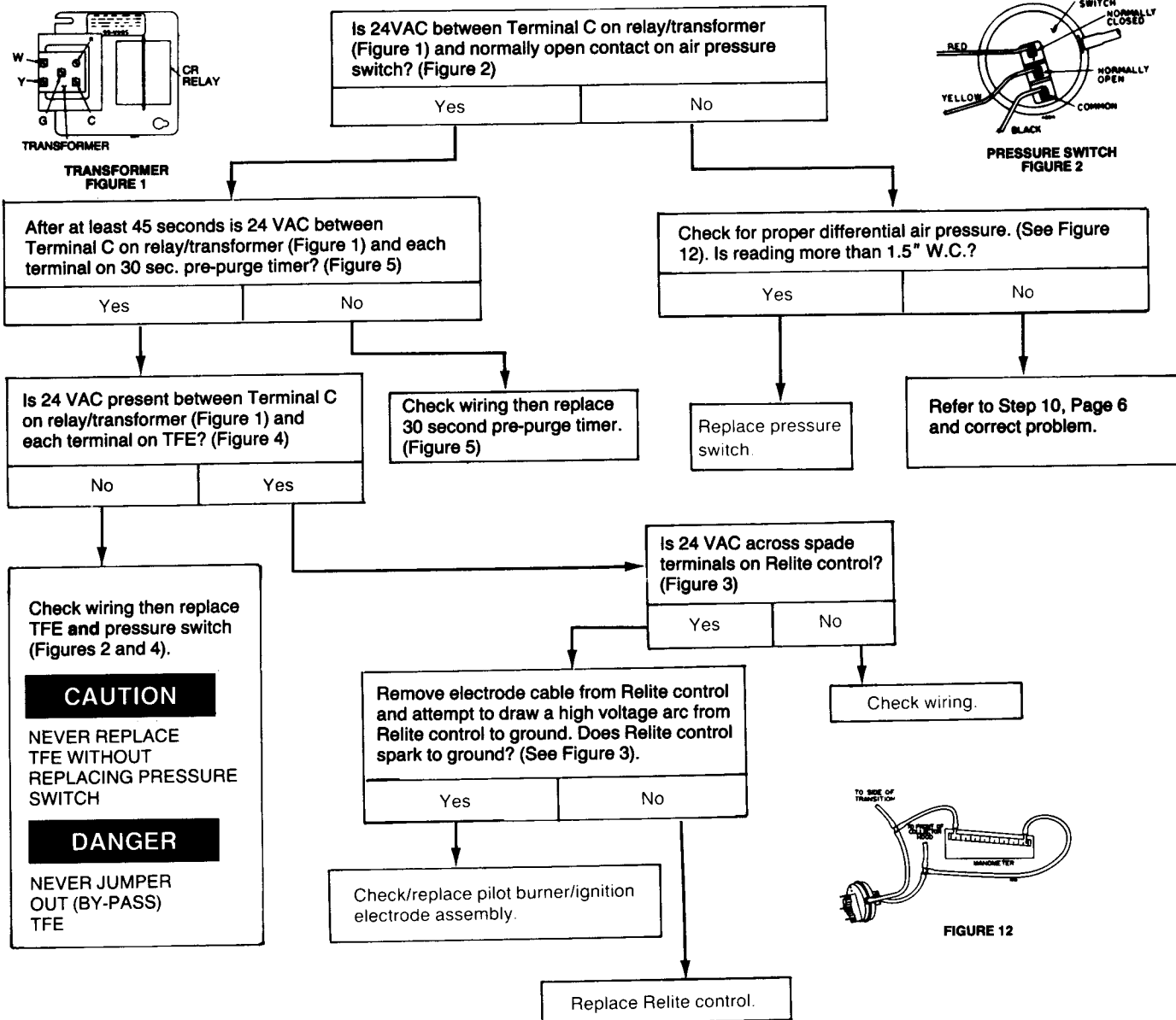
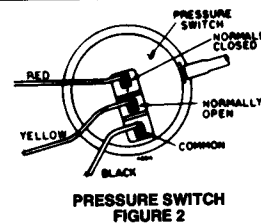
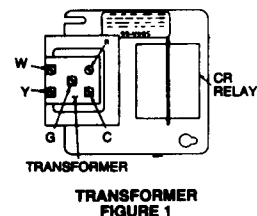

TABLE IV—NO SPARK AT PILOT—BLOWER & CIRCULATOR BOTH OPERATE





# HE and VHE® with White-Rodgers Cycle-Pilot® for Natural Gas Firing

## TABLE V—SPARK IS PRESENT—PILOT WILL NOT LIGHT

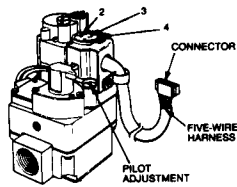

**36C84 GAS VALVE  
FIGURE 7**

Make sure all gas cocks and gas shut-off valves are open. Is the gas cock knob on the 36C84 valve in the "on" position? (Figure 6)

Yes

No

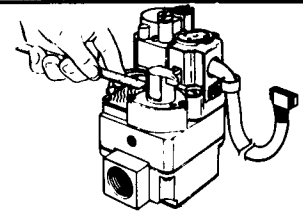

**CHECKING FOR ENERGIZED PILOT SOLENOID COIL. MAGNETIC PULL MEANS COIL IS "ON".  
FIGURE 9**

Is incoming pressure at least 5.0"?

Yes

No

Move gas cock knob to the "ON" position. (Figure 6)

Is 3098 Mercury Flame Sensor plugged into gas valve? (Figure 11)

Yes

No

If all gas cocks are open, contact the gas supplier. The 36C84 series valve requires a minimum of 5.0" W.C. inlet. (Figure 7)

Place a steel rule or small screwdriver blade across the top of the pilot solenoid coil. Is a magnetic pull felt? (Figure 9)

Yes

No

Firmly seat 3098 Flame Sensor into gas valve socket. (Figures 10-11)

Is 24 VAC across terminals C and L on 36C84 gas valve? (Figure 7)

Yes

No

Is gas present at the pilot burner? (Use a match taped to a long screwdriver or a pilot lighter to manually light pilot.) (Figure 8)

Yes

No

Check wiring to gas valve.

Check for ignition spark between the electrode tip and the sensing bulb. Does spark occur in the middle of the pilot gas stream.

Yes

No

Check for blocked pilot orifice or tubing. (Figure 8). If orifice and tubing are clear, replace gas valve. (Figure 7)

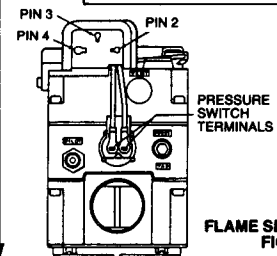

**FLAME SENSOR SOCKET  
FIGURE 10**

Check for physical damage to the pilot burners/electrode or debris near electrode. With a manually lit pilot flame, check the position of the tip of the ignition electrode. The tip should be in the soft blue portion of the pilot flame so that a spark to the pilot head will ignite pilot gas. On an ignition trial does the gas sputter past the spark? (See Figure 8)

Yes

No

Remove the flame sensor from valve socket, and place a jumper wire between holes 3 and 4 on the gas valve. With jumper in place, check for magnetic field on top of solenoid coil. If magnetic pull is not felt, replace gas valve. If pull is felt, check flame sensor/gas valve socket connections. Clean pins on sensor plug with emery cloth. (Figure 10). Replace flame sensor if condition is not corrected.

Check for weak ignition spark, spark occurring at locations other than ignition electrode, high drafts across pilot burner, and damaged pilot burner assembly. (Figure 8)

Decrease pilot gas pressure. Remove pilot adjust cover screw and rotate adjust screw clockwise to decrease gas pressure (Figure 7)

Attempt to increase pilot gas pressure by removing pilot adjust cover-screw and rotating pilot adjust screw counterclockwise. If pilot flame size does not increase, check for high drafts across pilot burner. (Figure 10)

TABLE VI—SPARK WILL NOT SHUT-OFF AFTER PILOT FLAME IS ESTABLISHED

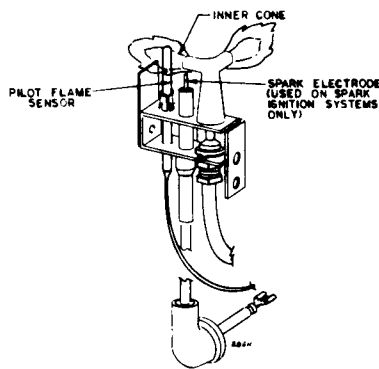
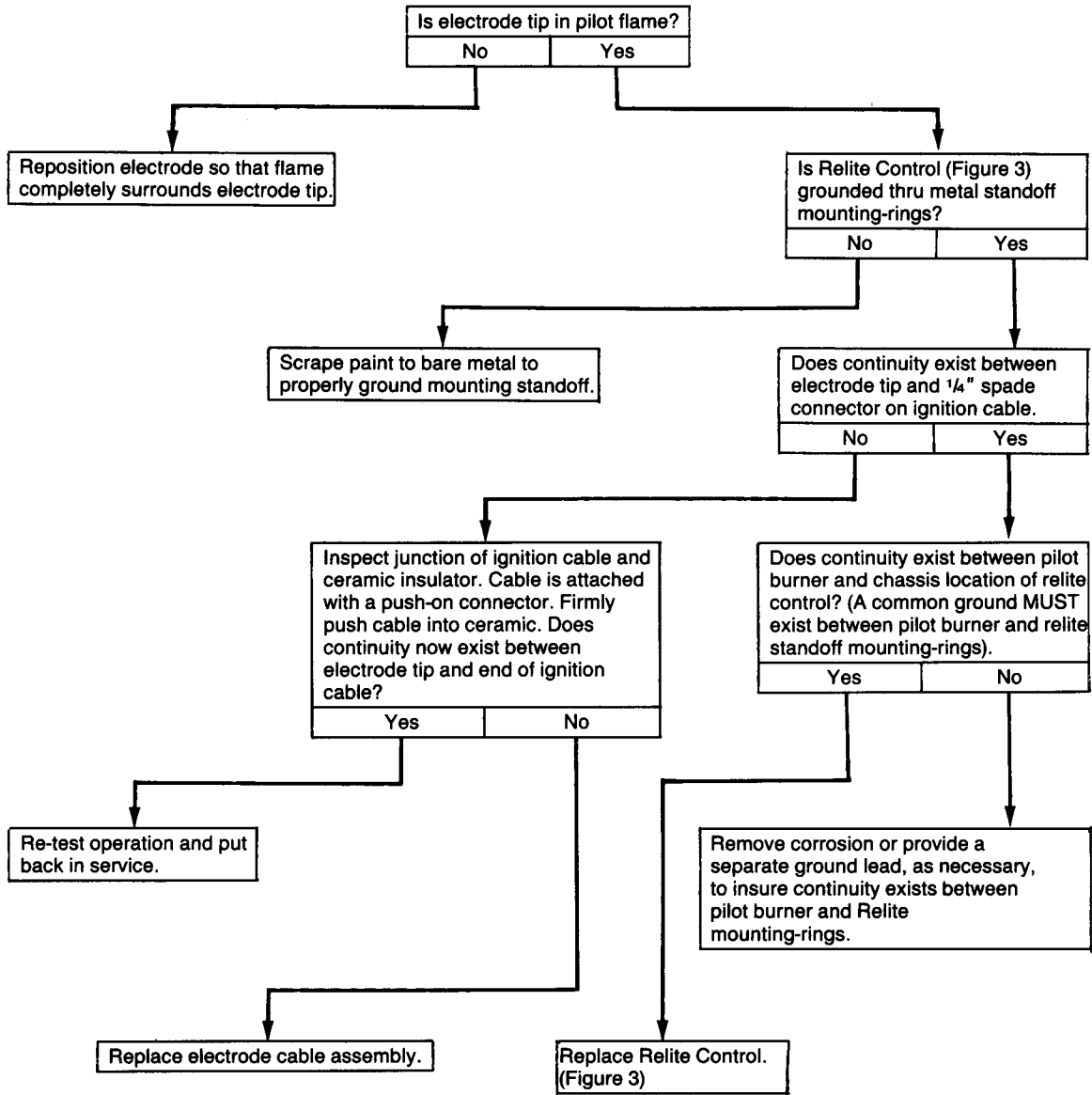

TYPICAL PILOT BURNER FLAME

TABLE VII—PILOT LIGHTS—NO MAIN BURNER IGNITION

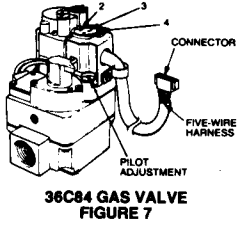

**CAUTION**

Access panel must be in position during boiler operation to prevent one or both of the following conditions:  
 A) Excessive delay in proving pilot (2 minutes or more).  
 B) A momentary flame rollout on ignition of main flame, which can melt the thermal fuse.

Is gas cock on 36C84 valve in "ON" position? (Figure 6)

Yes	No
-----	----

Move valve on "ON" position and cycle system. (Figure 6)

Unplug flame sensor from gas valve. Does pilot remain lit? (Figures 10–11)

Yes	No
-----	----

Insert a short jumper wire between holes 2 and 4 on the gas valve socket. CAUTION: This should energize the main valves. Does the main valve come on? (Figure 10)

Yes	No
-----	----

Is incoming gas pressure at least 5" W.C.?

Yes	No
-----	----

Replace gas valve.

Check for partially open gas cocks. Contact the gas supplier. The 36C84 valve requires an inlet pressure 5.0" W.C. for proper operation. (Figure 6)

Is upper 3/4" of flame sensor bulb engulfed by pilot flame? (Figures 8–11)

Yes	No
-----	----

Make sure sensing bulb is completely inserted to stop ring. Recycle system. (Figures 8–11)

Does the pilot valve close?

Yes	No
-----	----

Replace gas valve. (Figure 7)

Does continuity exist between sockets 2 and 4 on flame sensor receptacle? (Figure 10)

Yes	No
-----	----

Is incoming gas pressure at least 5.0" W.C.? (Figure 7)

Yes	No
-----	----

Check for poor connections between flame sensor plug and gas valve socket.

Check for partially open gas cocks. Contact the gas supplier. The 36C84 valve requires an inlet pressure 5.0" W.C. for proper operation. (Figure 26).

Replace flame sensor. (Figure 11)

Replace 36C84 gas valve. (Figure 7)

