

WEIL-McLAIN

MODELS HE (Series 2) AND VHE (Series 2)

PROPANE GAS-FIRED
INDUCED DRAFT BOILERS

**SUPPLEMENTAL
INSTRUCTIONS**
WITH WHITE-RODGERS
CYCLE-PILOT® SYSTEM FOR
PROPANE GAS-FIRED BOILERS

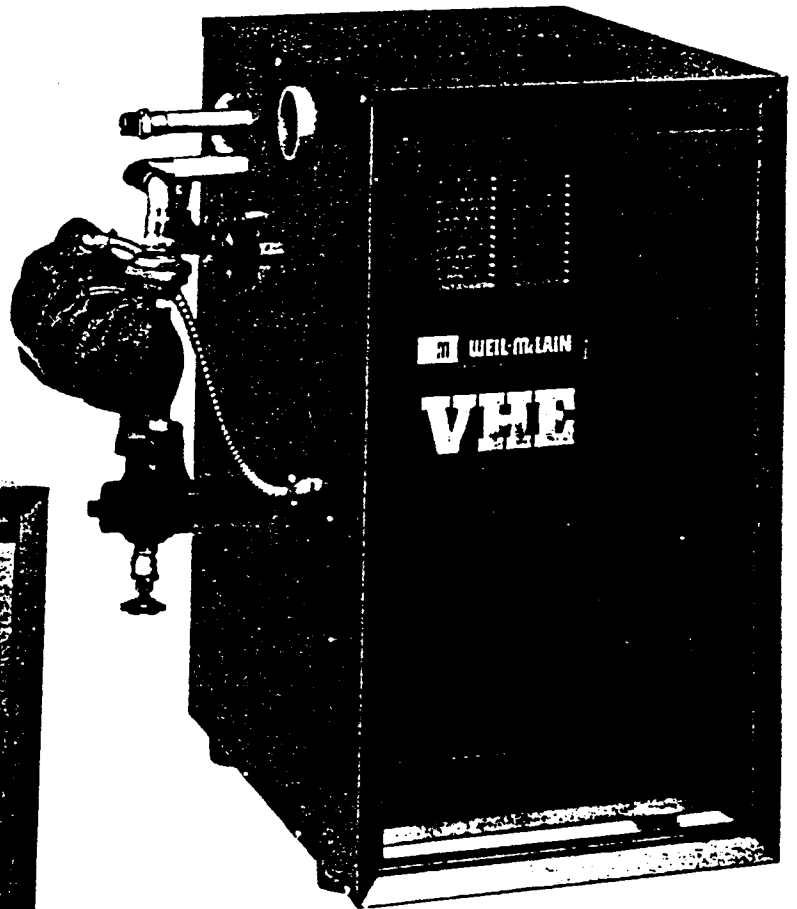

MODEL VHE (Series 2)

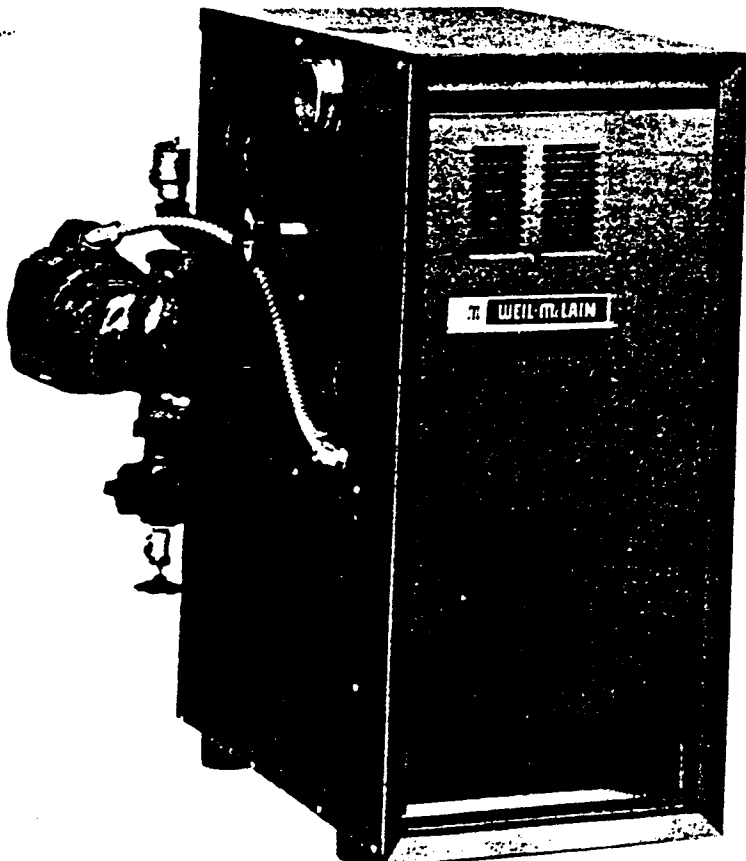

MODEL HE (Series 2)

PROPANE GAS

HE (Series 2) and VHE (Series 2) with White-Rodgers Cycle-Pilot® for Propane Gas Firing

TABLE OF CONTENTS

Base Assembly Parts Description
With White-Rodgers Cycle-Pilot®
For Propane Gas Firing 2

Ignition System Components 3

Boiler Equipment Components 4

Sequence of Operation 4

Schematic Wiring Diagram 5

Ladder Wiring Diagram 5

Trouble Shooting Procedure 6

Checking The Pressure Differential Switch 6

Trouble Shooting Charts 7-11

**HE (Series 2) and VHE (Series 2)
Base Assembly Parts Description
With White-Rodgers Cycle-Pilot®
For Propane Gas Firing**

FIGURE NO.	MODEL NO. PART DESCRIPTION	HE & VHE 3 QTY. PART NO.	HE & VHE 4 QTY. PART NO.	HE & VHE 5 QTY. PART NO.	HE & VHE 6 QTY. PART NO.
3	Relite Control w/Timer	1 511-330-118	1 511-330-118	1 511-330-118	1 511-330-118
7	Gas Valve Assembly	1 511-044-289	1 511-044-289	1 511-044-289	1 511-044-289
11	Switching Relay	1 510-350-224	1 510-350-224	1 510-350-224	1 510-350-224
■	Orifice, Main Burner Natural Gas No. 7 Drill	4 560-528-994 ⁹⁹⁰	6 560-528-994 ⁹⁹⁰	8 560-528-994 ⁹⁹⁰	10 560-528-994 ⁹⁹⁰
■	Orifice, Pilot Burner, Propane, w/Clip	1 560-528-944 ⁸	1 560-528-944 ⁸	1 560-528-944 ⁸	1 560-528-944 ⁸

*56
w/k
FLY. 2002
STO. ORIFICE LP
3-1-85*

■ Not Shown.

NOTE: PARTS LISTED ABOVE ARE FOR BOILERS FIRED WITH PROPANE GAS ONLY. FOR ADDITIONAL PARTS COMMON TO NATURAL AND PROPANE GASES REFER TO BOILER MANUAL.

IMPORTANT: When calling or writing about the boiler, PLEASE GIVE THE MODEL, SERIES, AND C.P. NUMBERS, located on the boiler.

Any reuse or reproduction of the artwork and copy in this manual is strictly prohibited without the written consent of Weil-McLain.



Michigan City, Indiana 46360 ■ A Marley Company



©Canada Weill-Canada LTD. 17EE 126441 Di Brampton Ontario L6T 1C7

**HE (Series 2) and VHE (Series 2)
WHITE-RODGERS CYCLE-PILOT® IGNITION SYSTEM COMPONENTS
FOR PROPANE GAS FIRING**

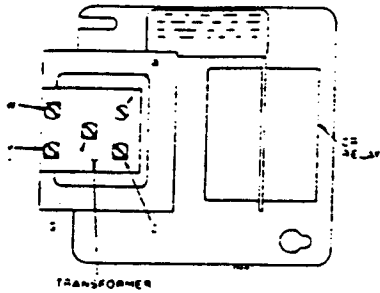

**TRANSFORMER
FIGURE 1**

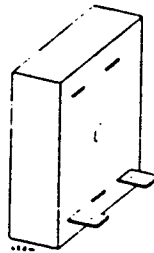

**PRE-PURGE TIMER
FIGURE 5**

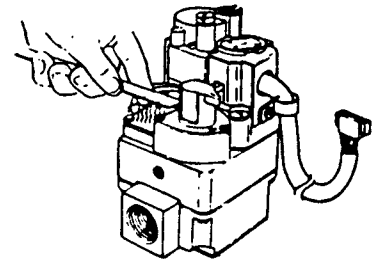

**CHECKING FOR ENERGIZED PILOT
SOLENOID COIL. MAGNETIC PULL
MEANS COIL IS "ON".
FIGURE 9**

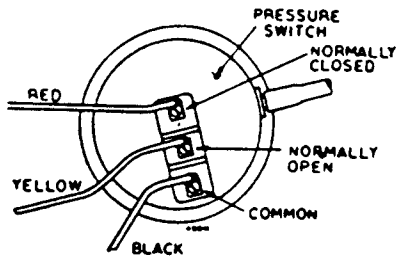

**PRESSURE SWITCH
FIGURE 2**

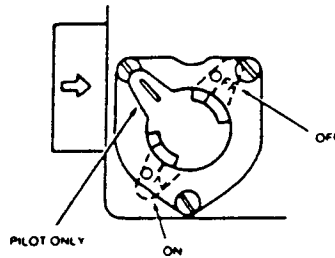

NOTE: When gas cock is positioned over black line on collar around knob, pilot will cycle on and off but main burner gas will not flow.

**36C87-207 GAS COCK KNOB
FIGURE 6**

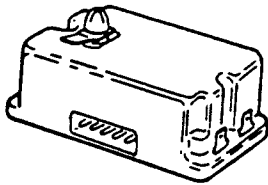

**5A22-201 RELITE CONTROL
FIGURE 3**

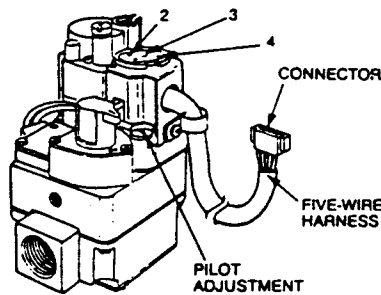

**36C87-207 GAS VALVE
FIGURE 7**

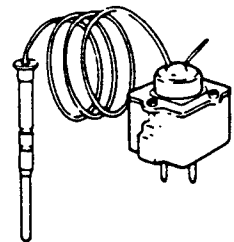

**3098 MERCURY FLAME SENSOR
FIGURE 10**

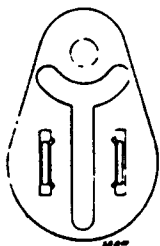

**THERMAL FUSE ELEMENT (TFE)
FIGURE 4**

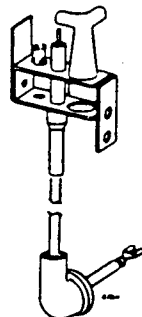

**E50-106 PILOT BURNER ASSY.
FIGURE 8**

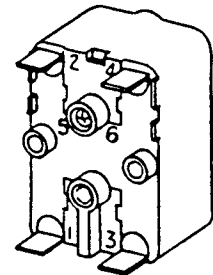

**SWITCHING RELAY
FIGURE 11**

Operation, Wiring Diagrams, Trouble Shooting

HE (Series 2) and VHE (Series 2) With White-Rodgers Cycle-Pilot® For Propane Gas Firing

BOILER EQUIPMENT COMPONENTS

BLOWER MOTOR

120/60/1, 3450 RPM permanent split capacitor motor with capacitor start and internal overload protection provides rotation of induced draft fan.

FAN (BLOWER WHEEL)

Develops induced draft to supply combustion air to boiler.

PRE-PURGE TIMER

Provides 30 second pre-purge prior to pilot ignition.

HIGH TEMPERATURE LIMIT CONTROL

In the event of high boiler water temperature, shuts down fan and burners but allows circulator to run as long as there is a call for heat from thermostat.

PRESSURE SWITCH

Detects pressure differential across fixed metering orifice to prove air flow through boiler.

COMBINATION PRESSURE AND TEMPERATURE GAUGE

Provides readings of boiler water pressure and temperature.

COMBINATION RELAY RECEPTACLE, JUNCTION BOX AND TRANSFORMER

120/24 VOLT 40 VA transformer provides low voltage for control circuit. Relay receptacle for plug-in circulator relay. Terminal strip for control circuit wiring.

PLUG-IN CIRCULATOR RELAY

Provides contact to energize circulator and fan and contact to prove operation of pressure switch.

ASME SAFETY PRESSURE RELIEF VALVE

Provides safety discharge in the event boiler water pressure exceeds 30 PSIG.

FILL-TROL SYSTEM (TYPES P-HE AND P-VHE ONLY)

Includes compression tank with permanent air cushion and combination manual shut-off valve, check valve, pressure reducing valve and strainer for automatic filling and maintaining minimum system pressure.

AUTOMATIC AIR VENT (TYPES P-HE AND P-VHE ONLY)

Vents air from boiler built-in air eliminator tapping.

GAS VALVE

Incorporates a pilot/redundant solenoid valve, integral pressure switch to sense incoming gas pressure, pressure regulator, main valve operator and socket to accept plug-in Mercury Flame Sensor.

MERCURY FLAME SENSOR

Consists of sensing bulb, capillary tube and diaphragm filled

with mercury and connected to SPDT switch. Heat from pilot vaporizes mercury causing diaphragm to snap switch.

RELITE CONTROL

Provides spark to light pilot and a safety timer function. If the pilot flame is not detected by the flame sensor within two minutes, the safety contact will open, de-energizing the gas valve, stopping all gas flow.

PILOT BURNER ASSEMBLY

Spark ignition pilot with mercury flame sensing probe.

THERMAL FUSE ELEMENT

Provides safety shutdown of burners and pilot if flame is not contained in firebox.

DRAIN VALVE

Used to drain boiler if necessary.

CIRCULATOR

Provides forced water circulation to hot water heating system.

SEQUENCE OF OPERATION

Referring to Ladder Diagram, Page 5.

1. Thermostat closes, activating relay CR (through pressure switch). Contacts CR1 and CR2 close:
 - a) CR2 activates circulator.
 - b) Blower is activated through limit switch.
 - c) CR1 provides a bypass around pressure switch to prove its operation.
2. When adequate draft is proven by pressure switch, the 30 second pre-purge timer starts.
3. After a 30 second delay, 24 VAC is provided to Relite Control through relay TR1 contact:
 - a) Spark voltage is provided to pilot.
 - b) Pilot gas valve is energized.
4. Pilot ignites:
 - a) Flame conduction stops spark from relite.
 - b) Mercury flame sensor opens main gas valve and pressure switch in gas valve holds pilot open.
5. After thermostat is satisfied, CR is deactivated:
 - a) CR2 opens turning off blower and pump.
 - b) CR1 opens turning off gas flow.
6. As air flow from blower reduces pressure, switch changes to normally closed position.
7. Boiler is now in "off" cycle.

SCHEMATIC WIRING DIAGRAM

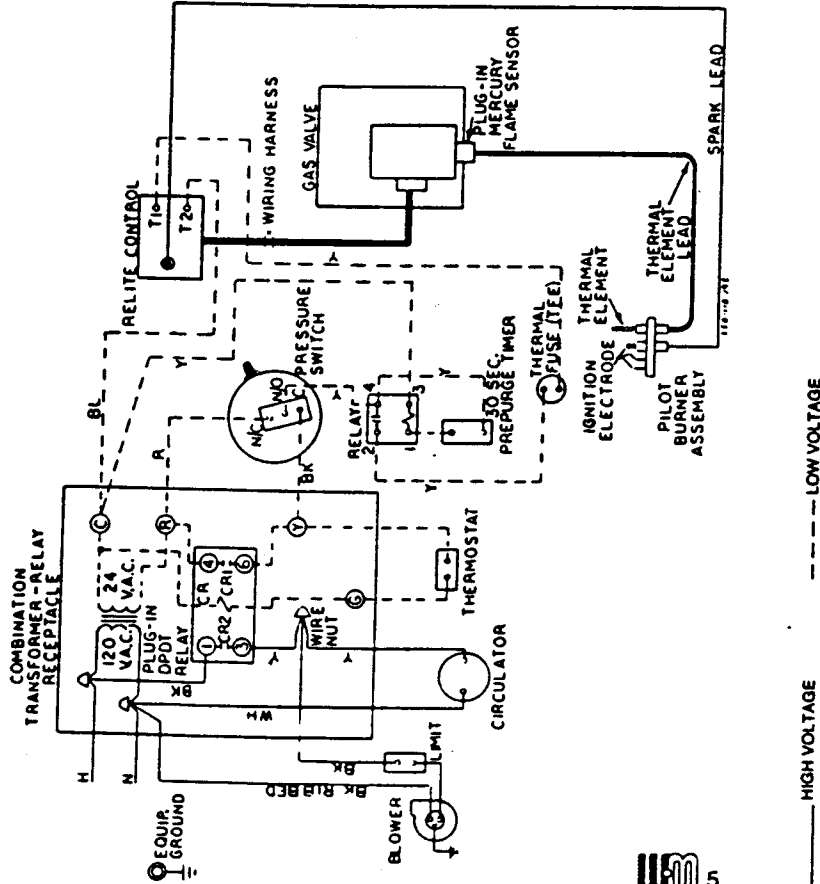

CAUTION DISCONNECT POWER SOURCE BEFORE INSTALLING AND/OR SERVICING UNIT.

- NOTES:
1. All wiring must be installed in accordance with the requirements of the National Electrical Code and any additional national, state, or local code requirements having jurisdiction.
 2. All safety circuit wiring must be N.E.C. Class 1.
 3. Refer to Control Components Instructions Sheets packed with boiler for application information.
 4. Use only 90°C Thermoplastic Wire, or equivalent, if any of the original wire must be replaced.

THERMOSTAT HEAT ANTICIPATOR SETTING		
SYSTEM	HE	VHE
WATER	0.40 AMPS.	0.40 AMPS.

LADDER WIRING DIAGRAM

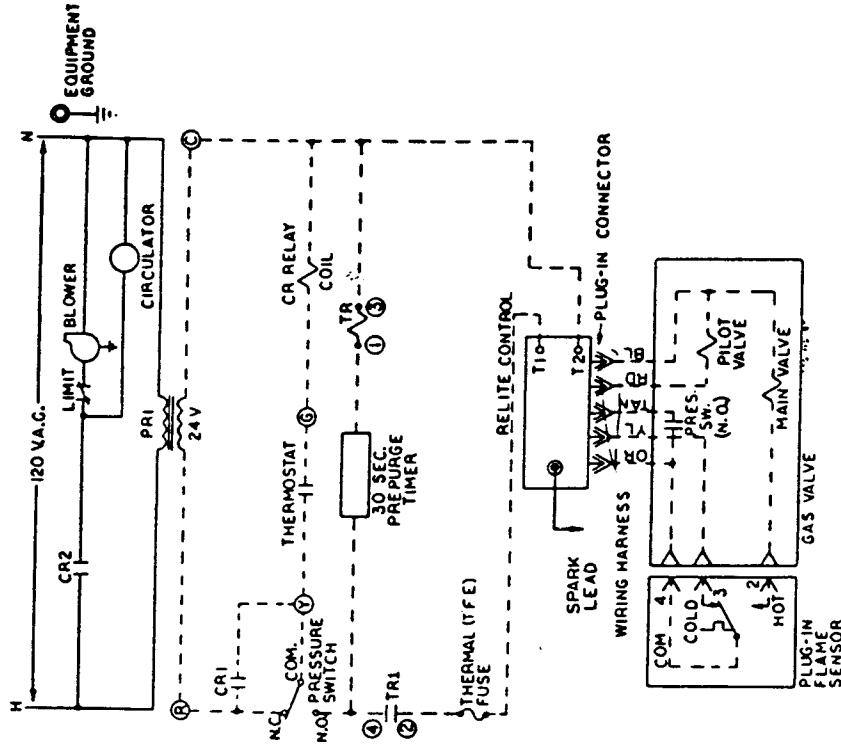

HE and VHE, Series 2 Boiler Schematic and Ladder Diagrams. PI Electronic Ignition Pilot System with White-Rodgers Cycle-Pilot Controls. Applicable to forced hot water boilers for propane gas firing.

WEIL-McLAIN
Michigan City, Indiana 46360
A Marley Company

TROUBLE SHOOTING PROCEDURE

DANGER

NEVER jumper out (by-pass) the Thermal Fuse Element (TFE) or any other safety device (except for momentary testing as outlined in Trouble Shooting Tables). A fire causing property damage and/or personal injury could result.

Control System is provided with flame failure "LOCK-OUT" feature. To reset "LOCK-OUT" circuit interrupt power to Relite Control for five minutes by either lowering thermostat setting or disconnecting power to boiler. For initial start-up, a number of trials may be required to bleed air from gas piping.

Before starting the trouble shooting procedure, be sure of the following:

1. You have a voltmeter capable of checking 120 VAC, 24 VAC and a continuity tester.
2. That 120 VAC power supply is available to the boiler (minimum 102 VAC, maximum 132 VAC).
3. That there is 24 VAC at the secondary side of the control transformer.
4. You have an inclined manometer with a range of 0-2.0" W.C.

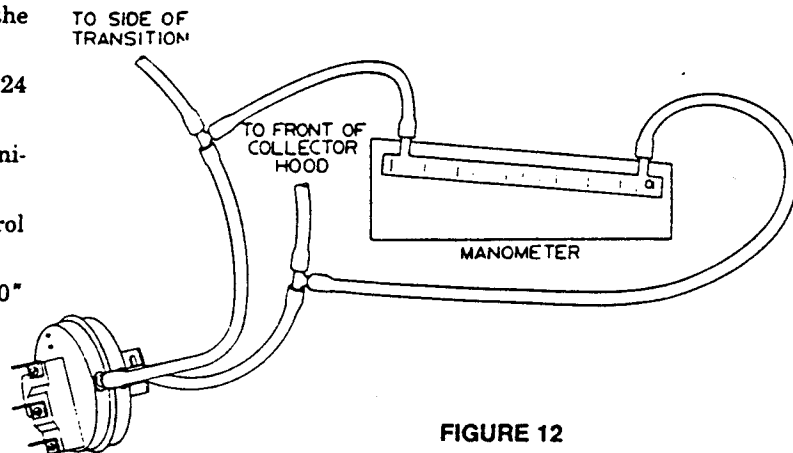

FIGURE 12

CHECKING THE PRESSURE DIFFERENTIAL SWITCH

Note: Make sure boiler water temperature is 100°F or cooler before beginning procedure.

1. Remove the sensing tube at the front of the pressure switch (closest to you as you face the boiler). Refer to Figure 12.
2. Install a "T" into the sensing tube and another piece of tubing from the "T" to the pressure switch.
3. Attach the third leg of the "T" to the suction side of an inclined manometer.
4. Remove the sensing tube at the rear of the pressure switch.
5. Install a "T" into the sensing tube and another piece of tubing from the "T" to the pressure switch.
6. Attach the third leg of the "T" to the pressure side of the manometer.
7. Close the manual main gas valve and set thermostat to call for heat. Blower will run but pilot and main burners will not ignite.
8. Check for 24 VAC between normally open terminal on pressure switch and terminal C on transformer (Figures 1 and 2).
9. If the reading on the manometer is at least 1.8 inches water column pressure, but there is not 24 V across N.O. terminal on pressure switch and terminal C, replace the pressure switch.
10. If the reading is lower than 1.8" W.C. look for the following causes:
 - a. Blockage in sensing tube.
 - b. Obstruction in the blower housing outlet.
 - c. Loose blower wheel on motor shaft.
 - d. Blower motor not at proper RPM.
 - e. Blower back plate not sealed properly.
 - f. Blockage in the block assembly.
 - g. Blockage in the flue pipe or termination.
11. When pressure reading is proper and pressure switch is operating properly, remove "T"'s and re-install sensing tubes to the pressure switch.

TABLE I—BLOWER AND CIRCULATOR WILL NOT OPERATE

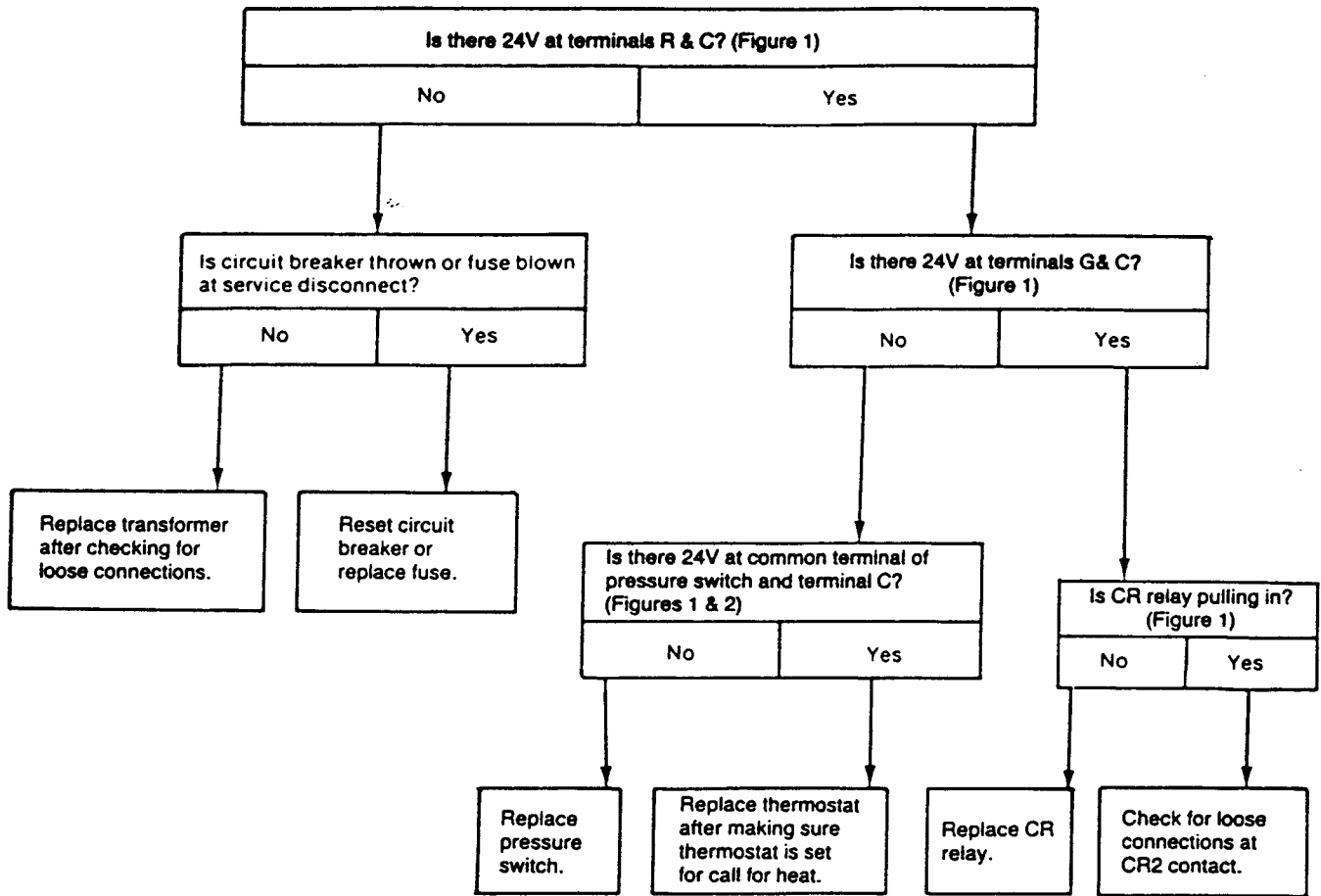
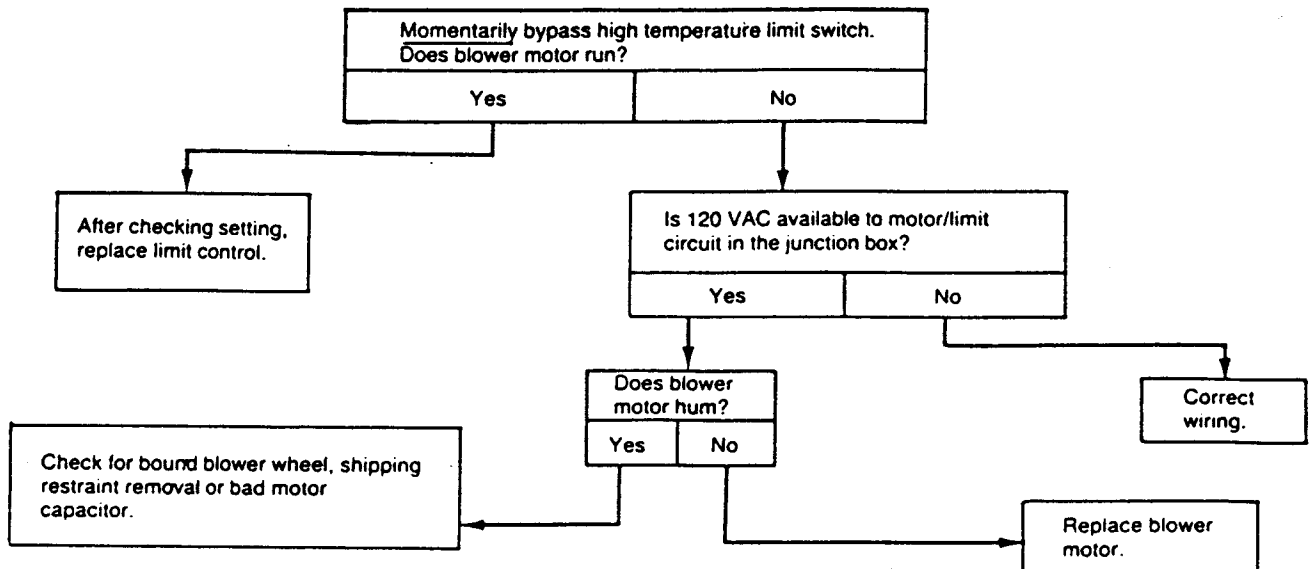

TABLE II—BLOWER WILL NOT OPERATE, BUT CIRCULATOR DOES OPERATE



HE (Series 2) and VHE (Series 2) with White-Rodgers Cycle-Pilot® for Propane Gas Firing

TABLE III—CIRCULATOR WILL NOT OPERATE, BUT BLOWER DOES OPERATE

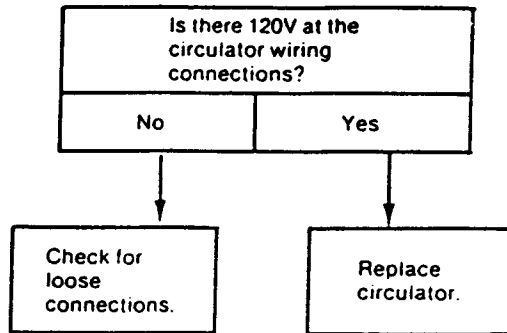
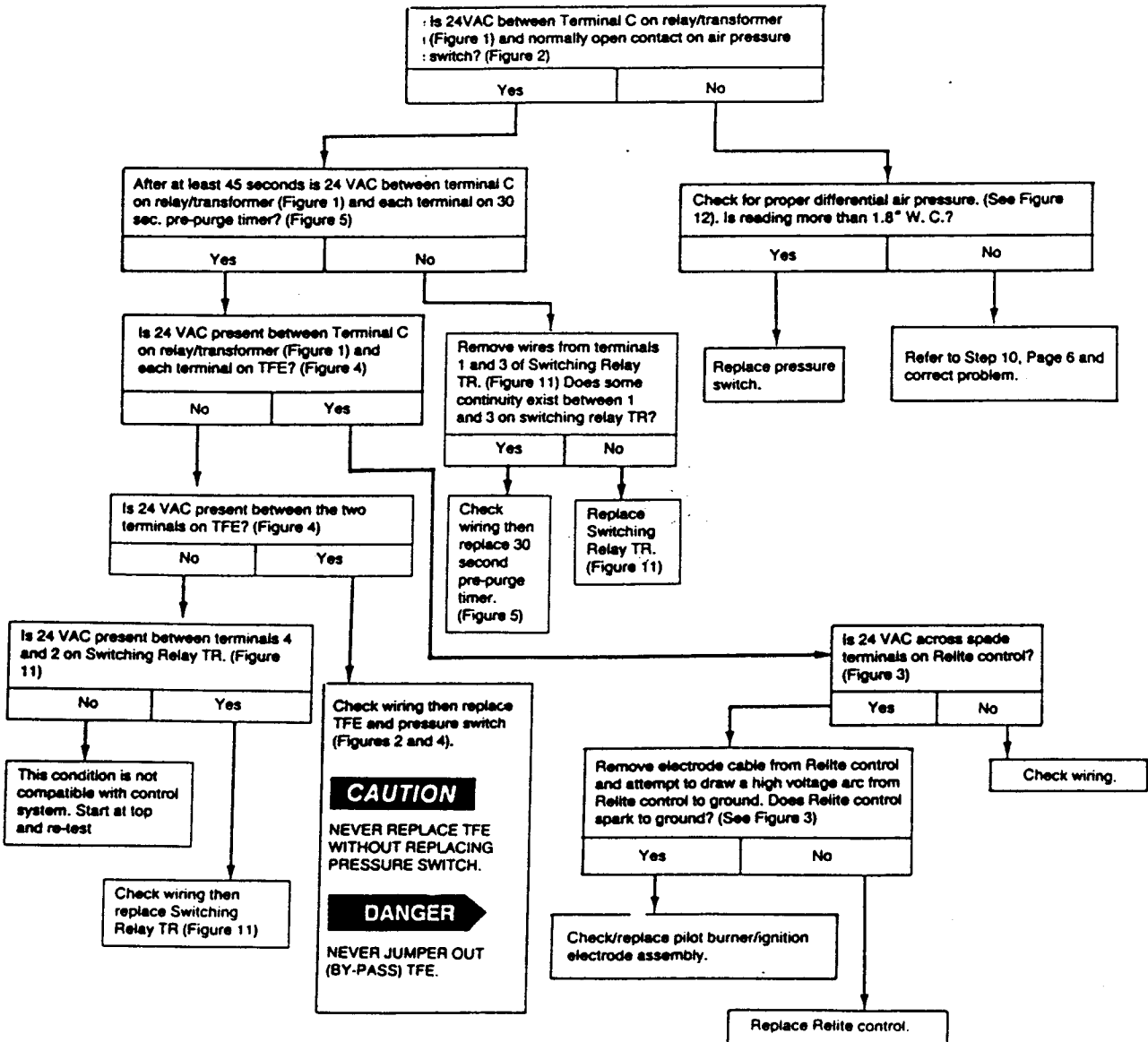
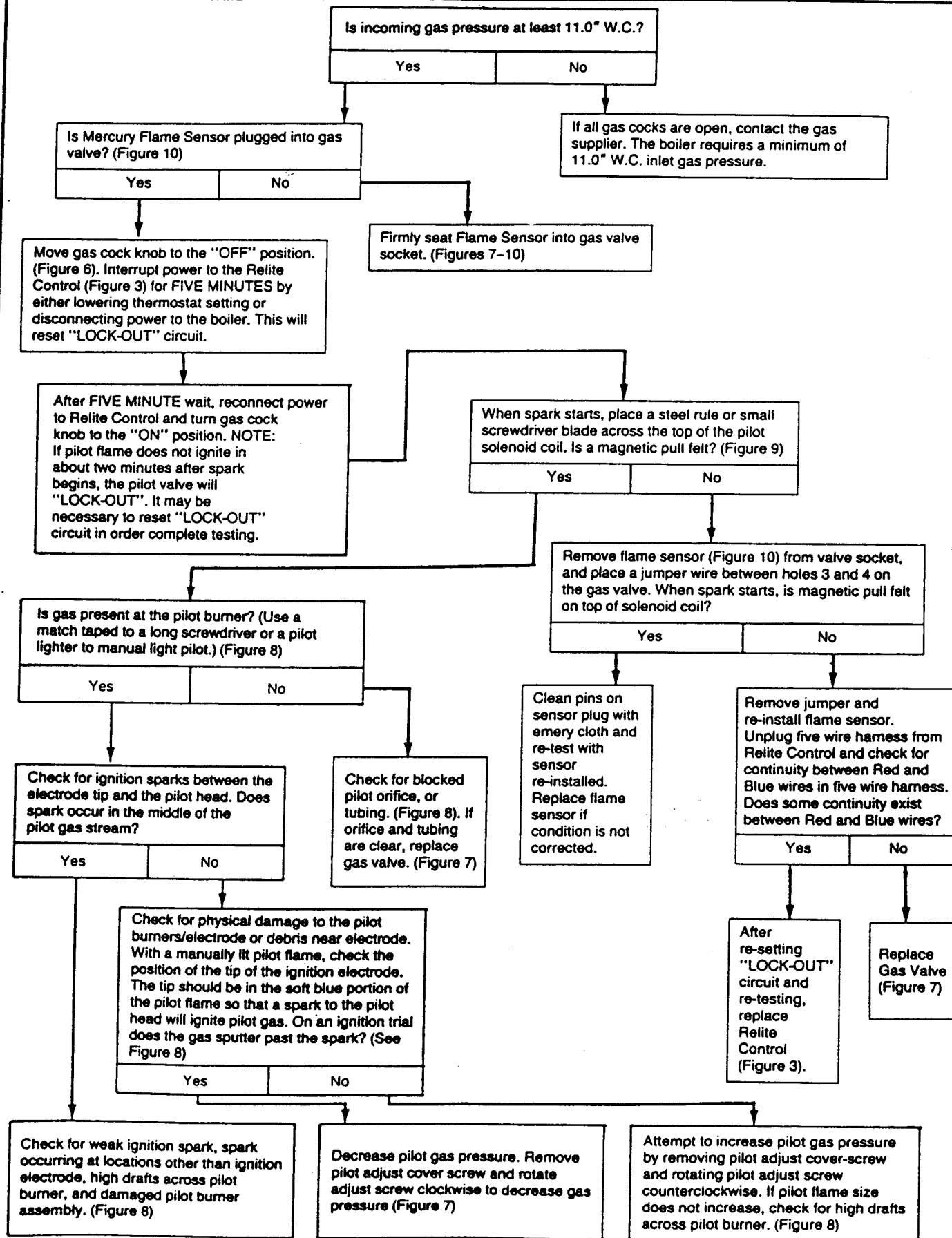

TABLE IV—NO SPARK AT PILOT—BLOWER & CIRCULATOR BOTH OPERATE



HE (Series 2) and VHE (Series 2) with White-Rodgers Cycle-Pilot® for Propane Gas Firing

TABLE V—SPARK IS PRESENT—PILOT WILL NOT LIGHT



HE (Series 2) and VHE (Series 2) with White-Rodgers Cycle-Pilot® for Propane Gas Firing

TABLE VI—SPARK WILL NOT SHUT-OFF AFTER PILOT FLAME IS ESTABLISHED

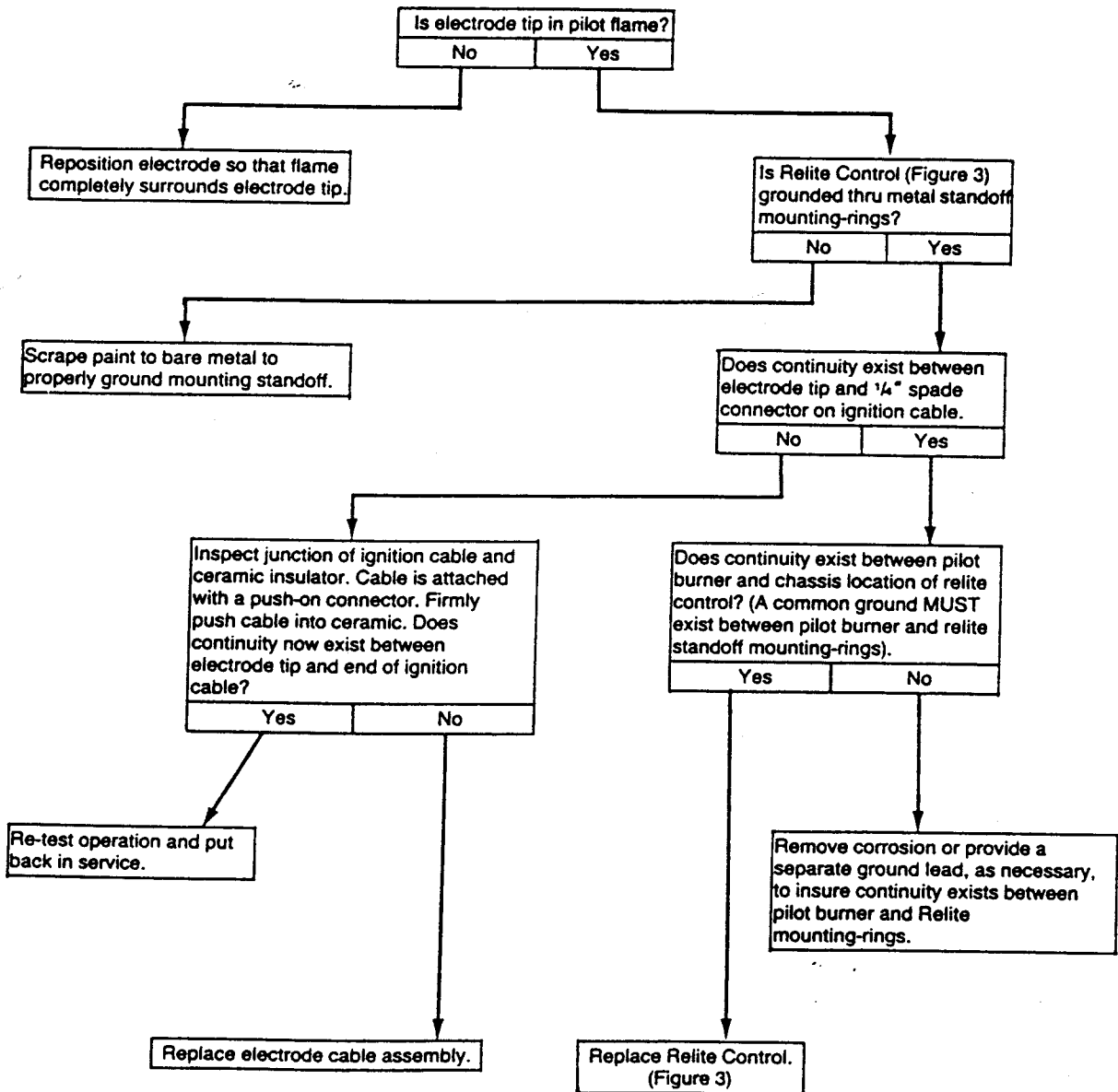

HE (Series 2) and VHE (Series 2) with White-Rodgers Cycle-Pilot® for Propane Gas Firing

TABLE VII—PILOT LIGHTS—NO MAIN BURNER IGNITION

